

MITSUBISHI

Q2AS(H)CPU(S1)

Mitsubishi Programmable Controller

User's Manual

(Hardware)

Thank you for purchasing the Mitsubishi programmable controller MELSEC-QnA series.

Prior to use, please read both this and relevant manual thoroughly to fully understand the product.



MODEL	Q2ASCPU-U(H/W)-E
MODEL CODE	13J857
IB(NA)-66677-K(1112)MEE	

● SAFETY PRECAUTIONS ●

(Read these precautions before using this product.)

Before using this product, please read this manual and the relevant manuals carefully and pay full attention to safety to handle the product correctly.

In this manual, the safety precautions are classified into two levels:

"⚠ WARNING" and "⚠ CAUTION".



Indicates that incorrect handling may cause hazardous conditions, resulting in death or severe injury.



Indicates that incorrect handling may cause hazardous conditions, resulting in minor or moderate injury or property damage.

Under some circumstances, failure to observe the precautions given under "⚠ CAUTION" may lead to serious consequences.

Observe the precautions of both levels because they are important for personal and system safety.

Make sure that the end users read this manual and then keep the manual in a safe place for future reference.

[DESIGN PRECAUTIONS]

⚠ WARNING

- Create a safety circuit outside the programmable controller to ensure the whole system will operate safely even if an external power failure or a programmable controller failure occurs.
Otherwise, incorrect output or malfunction may cause an accident.
 - (1) For an emergency stop circuit, protection circuit and interlock circuit that is designed for incompatible actions such as forward/reverse rotation or for damage prevention such as the upper/lower limit setting in positioning, any of them must be created outside the programmable controller.
Install the emergency stop switch outside the controlpanel so that workers can operate it easily.

DESIGN PRECAUTIONS]

WARNING

(2) When the programmable controller detects the following error conditions, it stops the operation and turn off all the outputs.

- The overcurrent protection device or overvoltage protection device of the power supply module is activated.
- The programmable controller CPU detects an error such as a watchdog timer error by the self-diagnostics function.

In the case of an error of a part such as an I/O control part that cannot be detected by the programmable controller CPU, all the outputs may turn on. In order to make all machines operate safely in such a case, set up a fail-safe circuit or a specific mechanism outside the programmable controller.

Refer to "LOADING AND INSTALLATION" in this manual for example fail safe circuits.

(3) Depending on the failure of the output module's relay or transistor, the output status may remain ON or OFF incorrectly. For output signals that may lead to a serious accident, create an external monitoring circuit.

- If load current more than the rating or overcurrent due to a short circuit in the load has flowed in the output module for a long time, it may cause a fire and smoke. Provide an external safety device such as a fuse.
- Design a circuit so that the external power will be supplied after power-up of the programmable controller.
Activating the external power supply prior to the programmable controller may result in an accident due to incorrect output or malfunction.
- For the operation status of each station at a communication error in data link, refer to the respective data link manual.
The communication error may result in an accident due to incorrect output or malfunction.

[DESIGN PRECAUTIONS]

WARNING

- When controlling a running programmable controller (data modification) by connecting a peripheral device to the CPU module or a PC to a special function module, create an interlock circuit on sequence programs so that the whole system functions safely all the time.

Also, before performing any other controls (e.g. program modification, operating status change (status control)), read the manual carefully and ensure the safety.

In these controls, especially the one from an external device to a programmable controller in a remote location, some programmable controller side problem may not be resolved immediately due to failure of data communications.

To prevent this, create an interlock circuit on sequence programs and establish corrective procedures for communication failure between the external device and the programmable controller CPU.

- When setting up the system, do not allow any empty slot on the base unit. If any slot is left empty, be sure to use a blank cover (A1SG60) or a dummy module (A1SG62) for it.

When using the extension base unit, A1S52B(S1), A1S55B(S1) or A1S58B(S1), attach the included dustproof cover to the module in slot 0.

Otherwise, internal parts of the module may be fried in the short circuit test or when an overcurrent or overvoltage is accidentally applied to external I/O section.

[DESIGN PRECAUTIONS]

CAUTION

- Do not install the control lines or communication cables together with the main circuit or power lines, or bring them close to each other. Keep a distance of 100mm (3.94inch) or more between them. Failure to do so may cause malfunctions due to noise.
- If having read register R outside the allowable range with the MOV instruction, the file register data will be FFFF_H. Using this as it is may cause malfunctions. Pay attention not to use any out-of-range file register when designing sequence programs. For instruction details, refer to the programming manual.
- When an output module is used to control the lamp load, heater, solenoid valve, etc., a large current (ten times larger than the normal one) may flow at the time that the output status changes from OFF to ON. Take some preventive measures such as replacing the output module with the one of a suitable current rating.
- Time from when the CPU module is powered on or is reset to when it enters in RUN status dependson the system configuration, parameter settings, and program size.
Design the program so that the entire system will always operate safely, regardless of the time.

[INSTALLATION PRECAUTIONS]

CAUTION

- Use the programmable controller under the environment specified in the user's manual.
Otherwise, it may cause electric shocks, fires, malfunctions, product deterioration or damage.
- Insert the module fixing projection into the fixing hole in the base unit and then tighten the module mounting screw within the specified torque.
When no screw is tightened, even if the module is installed correctly, it may cause malfunctions, a failure or a drop of the module.
Tightening the screw excessively may damage the screw and/or the module, resulting in a drop of the module, a short circuit or malfunctions.
- Connect the extension cable to the connector of the base unit or module.
Check the cable for incomplete connection after connecting it.
Poor electrical contact may cause incorrect inputs and/or outputs.
- Insert the memory card and fully press it to the memory card connector.
Check for incomplete connection after installing it.
Poor electrical contact may cause malfunctions.
- Be sure to shut off all phases of the external power supply used by the system before mounting or removing the module. Failure to do so may damage the module.
- Do not directly touch the conductive part or electronic components of the module.
Doing so may cause malfunctions or a failure of the module.

[WIRING PRECAUTIONS]

WARNING

- Be sure to shut off all phases of the external power supply used by the system before wiring.
Failure to do so may result in an electric shock or damage of the product.
- Before energizing and operating the system after wiring, be sure to attach the terminal cover supplied with the product.
Failure to do so may cause an electric shock.

CAUTION

- Always ground the FG and LG terminals to the protective ground conductor.
Failure to do so may cause an electric shock or malfunctions.
- Wire the module correctly after confirming the rated voltage and terminal layout.
Connecting a power supply of a different voltage rating or incorrect wiring may cause a fire or failure.
- Do not connect multiple power supply modules to one module in parallel.
The power supply modules may be heated, resulting in a fire or failure.
- Press, crimp or properly solder the connector for external connection with the specified tool.
Incomplete connection may cause a short circuit, fire or malfunctions.
- Tighten terminal screws within the specified torque range. If the screw is too loose, it may cause a short circuit, fire or malfunctions.
If too tight, it may damage the screw and/or the module, resulting in a short circuit or malfunctions.
- Carefully prevent foreign matter such as dust or wire chips from entering the module.
Failure to do so may cause a fire, failure or malfunctions.
- Install our programmable controller in a control panel for use.
Wire the main power supply to the power supply module installed in a control panel through a distribution terminal block.
Furthermore, the wiring and replacement of a power supply module have to be performed by a maintenance worker who acquainted with shock protection.
(For the wiring methods, refer to Type Q2AS(H)CPU(S1) User's Manual.)

[STARTUP AND MAINTENANCE PRECAUTIONS]

WARNING

- Do not touch any terminal during power distribution.
Doing so may cause an electric shock.
- Properly connect batteries. Do not charge, disassemble, heat or throw them into the fire and do not make them short-circuited and soldered. Incorrect battery handling may cause personal injuries or a fire due to exothermic heat, burst and/or ignition.
- Be sure to shut off all phases of the external power supply used by the system before cleaning or retightening the terminal screws or module mounting screws.
Failure to do so may result in an electric shock.
If they are too loose, it may cause a short circuit or malfunctions.
If too tight, it may cause damage to the screws and/or module, resulting in an accidental drop of the module, short circuit or malfunctions.

[STARTUP AND MAINTENANCE PRECAUTIONS]

CAUTION

- When performing online operations (especially, program modification, forced output or operating status change) by connecting a peripheral device to the running CPU module, read the manual carefully and ensure the safety. Incorrect operation will cause mechanical damage or accidents.
- Do not disassemble or modify each of modules.
Doing so may cause failure, malfunctions, personal injuries and/or a fire.
- When using a wireless communication device such as a mobile phone, keep a distance of 25cm (9.84inch) or more from the programmable controller in all directions.
Failure to do so may cause malfunctions.
- Be sure to shut off all phases of the external power supply used by the system before mounting or removing the module.
Failure to do so may result in failure or malfunctions of the module.
- Do not drop or apply any impact to the battery.
Doing so may damage the battery, resulting in electrolyte spillage inside the battery.
If any impact has been applied, discard the battery and never use it.
- Do not install/remove the terminal block more than 50 times after the first use of the product. (IEC 61131-2 compliant)
- Before handling modules, touch a grounded metal object to discharge the static electricity from the human body.
Failure to do so may cause failure or malfunctions of the module.

[DISPOSAL PRECAUTIONS]

CAUTION

- When disposing of the product, treat it as an industrial waste.
When disposing of batteries, separate them from other wastes according to the local regulations.
(For details of the battery directive in EU member states, refer to the Q2AS(H)CPU(S1) User's Manual.)

[TRANSPORTATION PRECAUTIONS]



CAUTION

- When transporting lithium batteries, make sure to treat them based on the transportation regulations. (Refer to Chapter 7 for details of the relevant models.)

●安全注意事项●

(使用之前请务必阅读)

在使用本产品之前，应仔细阅读本手册以及本手册中所介绍的相关手册，同时在充分注意安全的前提下正确操作。

在“安全注意事项”中，安全注意事项被分为“警告”和“注意”两个等级。

 **警告**

表示错误操作可能造成危险后果，导致死亡或重伤事故。

 **注意**

表示错误操作可能造成危险后果，导致中度伤害、轻伤或财产损失。

此外，根据情况不同，即使标注为“注意”的事项也有可能引发严重后果。这两个等级的注意事项记载的均为重要内容，请务必遵守。

请妥善保管本手册以备需要时取阅，并将本手册交给最终用户。

【设计注意事项】

⚠ 警告

- 应在可编程控制器外部设置一个安全电路，以保证整个系统在外电源异常或可编程控制器本体故障时也能安全运行。
否则可能由于误输出、误动作而导致事故发生。
 - (1) 应在可编程控制器外部配置紧急停止电路、保护电路、正转 / 反转等相反动作的互锁电路、定位的上限 / 下限等防止机械破损的互锁电路等。紧急停止开关应设置在控制盘外以便于作业人员操作。
 - (2) 可编程控制器在检测到下列异常状态时，会停止运算并 OFF 所有输出。
 - 电源模块的过电流保护装置或过电压保护装置工作时。
 - 可编程控制器 CPU 通过看门狗定时器出错等自诊断功能检测到异常时。此外，出现可编程控制器 CPU 所无法检测到的输入输出控制部分等的异常时，所有输出可能会为 ON。此时，应在可编程控制器外部设置一个失效安全电路或装置，以保证机械安全运行。关于失效安全电路的示例，请参照本手册的“实际安装与设置”。
 - (3) 输出模块的继电器以及晶体管等的故障可能会导致输出保持 ON 状态或 OFF 状态。对于可能导致重大事故发生的输出信号，应在外部设置监视电路。
- 输出模块因为超过额定的负载电流或负载短路等导致长时间过电流时，可能会导致冒烟、火灾，因此请在外部设置保险丝等安全电路。
- 应配置成在可编程控制器本体电源接通后再接通外部供应电源的电路。如果外部供应电源先接通，可能由于误输出或误动作而导致事故发生。
- 关于数据链接出现通信异常时各站的动作状态，请参照各数据链接的手册。否则可能由于误输出、误动作而导致事故发生。

【设计注意事项】

⚠ 警告

- 在 CPU 模块上连接外围设备，或在特殊功能模块上连接计算机等以对运行中的可编程控制器进行控制（数据更改）前，应在顺控程序上配置互锁电路，以保证整个系统始终能安全运行。
此外，对运行中的可编程控制器进行其他控制（程序更改、运行状态更改（状态控制））前，应仔细阅读相关手册，在充分确认安全的基础上进行操作。
特别是在通过外部设备对远程的可编程控制器进行上述控制时，可能会因为数据通信异常而导致无法立即对可编程控制器侧的故障做出反应。
在顺控程序上配置互锁电路的同时，应在外部设备与可编程控制器 CPU 之间确定发生数据通信异常时的系统的处理方法。
- 配置系统时，请勿在基板上设置空余插槽。
出现空余插槽时，必须使用空槽盖板（A1SG60）、虚拟模块（A1SG62）。
此外，使用扩展基板 A1S52B、A1S55B、A1S58B 时，必须在 0 号插槽的模块上安装附带的防尘盖板。
进行短路试验时，或误对外部输入输出部施加过电流或过电压时，模块的内部部件可能会四处飞散。

【设计注意事项】

⚠ 注意

- 请勿将控制线及通信电缆与主电路及动力线等捆扎在一起或相互靠得太近。应相距大约 100mm 以上距离。
因为噪声有可能导致误动作。
- 通过 MOV 命令等读取超出范围的文件寄存器 R 时，文件寄存器的数据将变为 FFFFh，如果直接使用可能会导致误动作。设计顺控程序时应注意避免使用超出范围的文件寄存器。关于命令的详细内容，请参照编程手册。
- 通过输出模块控制指示灯负载、加热器、电磁阀等时，输出 OFF → ON 时可能会有大电流（通常的 10 倍左右）流过，因此请采取改用具有足够额定电流的输出模块等措施。
- CPU 模块的电源关闭→接通或复位时，CPU 模块变为 RUN 状态为止的时间会因系统配置、参数设置、程序容量等而变动。
应通过设计使得在变为 RUN 状态为止的时间发生变动时也能保证整个系统安全运行。

【安装注意事项】

⚠ 注意

- 应在本手册记载的一般规格环境下使用可编程控制器。
如果在一般规格范围以外的环境中使用可编程控制器，可能导致触电、火灾、误动作、产品损坏或性能劣化。
- 请将模块下部的模块固定用凸起部切实插入基板的固定孔后，以规定的扭矩拧紧模块安装螺栓。如果模块未正确安装并以螺栓固定，有可能造成误动作、故障或掉落。
如果螺栓拧得过紧，有可能造成螺栓及模块破损从而导致掉落、短路或误动作。
- 扩展电缆应切实安装到基板的扩展电缆用接口上。
安装后应检查有无浮起。
因为接触不良有可能导致误输入、误输出。
- 存储卡应接入存储卡安装用接口中并切实安装。
安装后应检查有无浮起。
因为接触不良有可能导致误动作。
- 在拆装模块时，必须将系统使用的外部供应电源全部断开后再进行操作。
如果未全部断开，有可能导致产品损坏。
- 请勿直接触碰模块的导电部分及电子部件。
否则可能导致模块误动作、故障。

【配线注意事项】

⚠ 警告

- 在配线作业等时，必须将系统使用的外部供应电源全部断开后再进行操作。如果未全部断开，有可能导致触电或产品损坏。
- 配线作业结束后进行通电、运行时，必须安装产品附带的端子盖板。如果未安装端子盖板，有可能导致触电。

⚠ 注意

- 必须将 FG 端子及 LG 端子与可编程控制器的专用接地线连接。否则有可能导致触电、误动作。
- 进行模块配线作业时，应在确认产品的额定电压及端子排列的基础上正确进行操作。
如果连接了与额定值不符的电源或配线错误，可能导致火灾或故障。
- 请勿将多个电源模块的输出并联。
否则电源模块会过热，可能导致火灾或故障。
- 外部连接用接口应使用生产厂商指定的工具进行压装、压接或正确焊接。
如果连接不牢固，可能导致短路、火灾或误动作。
- 应在规定的扭矩范围内拧紧端子螺栓。
如果端子螺栓拧得过松，有可能导致短路、火灾或误动作。
如果端子螺栓拧得过紧，有可能造成螺栓及模块破损从而导致掉落、短路或误动作。
- 应注意防止切屑及配线头等异物掉入模块内。
否则有可能导致火灾、故障或误动作。
- 本公司的可编程控制器应设置在控制盘内使用。
与设置在控制盘内的可编程控制器电源模块之间的主电源配线应经由中继端子排进行。
此外，电源模块的更换和配线作业应由接受过充分的触电防护教育的维护作业人员进行。
配线方法请参照 Q2AS(H)CPU(S1) 用户手册（详细篇）。

【启动 / 维护注意事项】

警告

- 在通电状态下请勿触摸端子。
否则可能导致触电。
- 应正确连接电池。
请勿进行充电、拆解、加热、投入火中、短接、焊接等。
如果错误使用电池，有可能因为电池发热、破裂或起火等而导致人身伤害或火灾。
- 在清洁模块或重新紧固端子螺栓、模块安装螺栓时，必须将系统使用的外部供应电源全部断开后再进行操作。
如果未全部断开，有可能导致触电。
如果端子螺栓拧得过松，有可能导致短路、误动作。
如果螺栓拧得过紧，有可能造成螺栓及模块破损从而导致掉落、短路或误动作。

注意

- 把外围设备连接到运行中的 CPU 模块上进行在线操作（特别是程序更改、强制输出、运行状态的更改）前，应仔细阅读手册，在充分确认安全的基础上进行操作。
否则操作错误有可能导致机械破损或事故发生。
- 请勿拆解或改造各模块。
否则可能导致故障、误动作、人身伤害或火灾。
- 便携电话或 PHS 等无线通信设备应在距离可编程控制器本体（各个方向）25cm 以上的地方使用。
否则可能导致误动作。
- 在拆装模块时，必须将系统使用的外部供应电源全部断开后再进行操作。
如果未全部断开，有可能导致模块故障或误动作。
- 产品投入使用后，模块和基板以及端子排的拆装次数不应超过 50 次。
（根据 IEC61131-2 规范）
如果超过了 50 次，有可能导致误动作。
- 请勿使模块中安装的电池掉落或受到撞击。
掉落或受到撞击可能会导致电池破损，造成电池内部发生漏液。
掉落或受到撞击的电池不可使用，应予以报废。

【启动 / 维护注意事项】

注意

- 在触碰模块之前，必须先触碰已接地的金属等，释放掉人体等所携带的静电。如果不释放掉静电，有可能导致模块故障或误动作。

【报废处理注意事项】

注意

- 本产品报废时，应当作工业废物处理。
电池报废时应根据各地区所制定的法律法规分别进行。（关于欧盟成员国的电池管制的详细内容，请参照 Q2AS (H) CPU (S1) 用户手册（详细篇）。）

【运输注意事项】

注意

- 在运输含锂电池时，应根据运输管制进行处理。（管制对象机种的详细内容请参照第 7 章。）

● CONDITIONS OF USE FOR THE PRODUCT ●

- (1) Mitsubishi programmable controller ("the PRODUCT") shall be used in conditions;
- where any problem, fault or failure occurring in the PRODUCT, if any, shall not lead to any major or serious accident; and
 - where the backup and fail-safe function are systematically or automatically provided outside of the PRODUCT for the case of any problem, fault or failure occurring in the PRODUCT.
- (2) The PRODUCT has been designed and manufactured for the purpose of being used in general industries.
- MITSUBISHI SHALL HAVE NO RESPONSIBILITY OR LIABILITY (INCLUDING, BUT NOT LIMITED TO ANY AND ALL RESPONSIBILITY OR LIABILITY BASED ON CONTRACT, WARRANTY, TORT, PRODUCT LIABILITY) FOR ANY INJURY OR DEATH TO PERSONS OR LOSS OR DAMAGE TO PROPERTY CAUSED BY the PRODUCT THAT ARE OPERATED OR USED IN APPLICATION NOT INTENDED OR EXCLUDED BY INSTRUCTIONS, PRECAUTIONS, OR WARNING CONTAINED IN MITSUBISHI'S USER, INSTRUCTION AND/OR SAFETY MANUALS, TECHNICAL BULLETINS AND GUIDELINES FOR the PRODUCT.
- ("Prohibited Application")
- Prohibited Applications include, but not limited to, the use of the PRODUCT in;
- Nuclear Power Plants and any other power plants operated by Power companies, and/or any other cases in which the public could be affected if any problem or fault occurs in the PRODUCT.
 - Railway companies or Public service purposes, and/or any other cases in which establishment of a special quality assurance system is required by the Purchaser or End User.
 - Aircraft or Aerospace, Medical applications, Train equipment, transport equipment such as Elevator and Escalator, Incineration and Fuel devices, Vehicles, Manned transportation, Equipment for Recreation and Amusement, and Safety devices, handling of Nuclear or Hazardous Materials or Chemicals, Mining and Drilling, and/or other applications where there is a significant risk of injury to the public or property.

Notwithstanding the above, restrictions Mitsubishi may in its sole discretion, authorize use of the PRODUCT in one or more of the Prohibited Applications, provided that the usage of the PRODUCT is limited only for the specific applications agreed to by Mitsubishi and provided further that no special quality assurance or fail-safe, redundant or other safety features which exceed the general specifications of the PRODUCTS are required. For details, please contact the Mitsubishi representative in your region.

REVISIONS

*The manual number is given on the bottom right of the front cover.

Print Date	*Manual Number	Revision
Jan., 1996	IB(NA) 66677-A	First edition
Sep., 1998	IB(NA) 66677-B	<p>Correction SAFETY PRECAUTIONS, Section 4.5.2</p> <p>Addition Specifications, Performance specifications, EMC standards, Low-Voltage instruction</p> <p>Deletion I/O module specifications and connections</p>
Dec., 2002	IB(NA) 66677-C	<p>Equivalent to Japanese version E</p> <p>Correction SAFETY PRECAUTIONS, 1.1, Chapter 3, Section 4.2, 4.3.1, 4.3.2, 4.5.2, Chapter 5, Chapter 6, Section 6.2</p>
Dec., 2003	IB(NA) 66677-D	<p>Addition of model A1SY42P</p> <p>Addition Chapter 7, Section 7.1, 7.2</p> <p>Correction SAFETY PRECAUTIONS, Section 5.2.1, 5.2.2, 5.3.1, 5.3.2, 6.2</p>
Jul., 2005	IB(NA) 66677-E	<p>Correction SAFETY PRECAUTIONS, Section 1.1, Chapter 3, Section 3.1, 3.1.1, 3.1.2, 3.1.3, 3.2, 3.2.4, 3.2.7, 4.1.1, 4.2, 4.3.1, 4.3.2, 4.3.3, 4.3.4, 4.4, 6.2, 6.3</p> <p>Section change Section 6.1, 6.2 are changed to Section 6.2, 6.3, respectively.</p>
Oct., 2006	IB(NA) 66677-F	<p>Addition of model A1SY40P, A1SY41P</p> <p>Addition Section 6.5, 6.6, 6.7, 6.8, 6.9, 6.10</p> <p>Correction SAFETY PRECAUTIONS, Section 1.1, 3.1.3, 3.2.4, 3.2.6, 4.1.1, 4.1.3, 4.3.2, 4.3.3, 4.3.4, 5.2.1, 5.2.2, Chapter 6</p>
May, 2007	IB(NA) 66677-G	<p>Partial Correction Section 3.1.1, 3.1.3, 3.1.4, 3.2.7, 4.3.3, 4.3.4, 5.2.1, 6.3</p>
Oct., 2008	IB(NA) 66677-H	<p>Partial Correction SAFETY PRECAUTIONS, Section 1.1, 3.1, 3.1.1, 3.1.2, 3.1.3, 3.2, 3.2.1, 3.2.2, 3.2.3, 3.2.4, 3.2.5, 3.2.6, 3.2.7, 4.1.3, 4.2, 4.3.3, 4.3.4, 4.5.2, 5.1.1, 5.2.1, Chapter 6</p>

*The manual number is given on the bottom right of the front cover.

Print Date	*Manual Number	Revision
Jul., 2009	IB(NA) 66677-I	<u>Partial Correction</u> Section 1.1, Chapter 3, Section 6.3
Jan., 2011	IB(NA) 66677-J	<u>Partial Correction</u> SAFETY PRECAUTIONS, CONDITIONS OF USE FOR THE PRODUCT, Relavant Manuals, Section 1.1, 2.1, Chapter 3, Section 3.1, 3.1.1, 3.1.3, 3.1.4, 3.1.6, 4.2, 4.3.1, 4.3.3, 4.4, 5.1.1, 5.1.2, 5.2.1, 5.2.2, 5.3.1, 5.3.2 <u>Addition</u> Section 3.1.8, 3.1.9
Dec., 2011	IB(NA) 66677-K	<u>Partial Correction</u> Section 1.1, 3.1.1, 6.3.5 <u>Addition</u> SAFETY PRECAUTIONS(Chinese)

Japanese Manual Version IB(NA)68653-N

This manual confers no industrial property rights or any rights of any other kind, nor dose it confer any patent licenses. Mitsubishi Electric Corporation cannot be held responsible for any problems involving industrial property rights which may occur as a result of using the contents noted in this manual.

CONTENTS

1. SPECIFICATIONS	1
1.1 SPECIFICATIONS	1
2. PERFORMANCE SPECIFICATION	3
2.1 QnASCPU Module Performance Specification	3
3. EMC DIRECTIVES AND LOW VOLTAGE DIRECTIVES	5
3.1 Requirements for Compliance with EMC Directives	5
3.1.1 EMC standards	6
3.1.2 Installation instructions for EMC Directive	8
3.1.3 Cables	10
3.1.4 Power supply module	16
3.1.5 Base unit	17
3.1.6 Ferrite core	17
3.1.7 Noise filter (power supply line filter)	18
3.1.8 Power line for external power supply terminal	18
3.1.9 Installation environment of the CC-Link/LT module and the AS-i module	19
3.2 Requirements for Compliance with Low Voltage Directives	20
3.2.1 Standard applied for MELSECs-QnA series programmable controller 20	
3.2.2 Precautions when using the MELSEC-QnA series programmable controller	21
3.2.3 Power supply	22
3.2.4 Control panel	23
3.2.5 Module installation	24
3.2.6 Grounding	24
3.2.7 External wiring	25
4. LOADING AND INSTALLATION	26
4.1 Installing the Module	26
4.1.1 Notes on handling the module	26
4.1.2 Installation environment	27
4.1.3 Notes on installing the base unit	28
4.2 Fail-Safe Circuit Concept	31
4.3 Wiring	35
4.3.1 Power supply module specifications	35
4.3.2 Parts names	37
4.3.3 Wiring instructions	38
4.3.4 Wiring to module terminals	42
4.4 Precautions when Connecting the Uninterruptible Power Supply (UPS)	43
4.5 Part names and Settings	44
4.5.1 Part names and settings	44

4.5.2 Relation between switch operation and the LED indication	47
5. SPECIFICATION AND CONNECTION OF I/O MODULES	52
5.1 Input modules	52
5.1.1 Input module specifications	52
5.1.2 Input module connections	56
5.2 Output modules	60
5.2.1 Output module specifications	60
5.2.2 Output module connections	66
5.3 Input/output combined modules	74
5.3.1 Input/output combined module specifications	74
5.3.2 Input/output composite module connections	76
6. ERROR CODE	78
6.1 Error Code Type	79
6.2 Reading Error Code	80
6.3 Error Code List	81
6.4 Canceling of Errors	133
7. TRANSPORTATION PRECAUTIONS	134
7.1 Relevant Models	134
7.2 Transportation Guidelines	134

This manual explains safety precautions, I/O module wiring, and error codes regarding the Q2ASCPU, Q2ASCPU-S1, Q2ASHCPU, and Q2ASHCPU-S1 (hereinafter, these are all referred to as Q2ASCPU).

About this manual

The following tables show the manuals relevant to this product. Refer to these tables when you order a manual, if necessary.

Detailed Manual

Manual title	Manual number (Type code)
type Q2AS(H)CPU(S1) User's Manual This manual explains performance, functions, and handling of the Q2ASCPU, Q2ASCPU-S1, Q2ASHCPU, and Q2ASHCPU-S1, power supply, memory card, specifications, and handling of the base unit. (sold separately)	SH-3599 (13J858)

Relavnt Manuals

Manual title	Manual number (Type code)
QnACPU-GUIDEBOOK This manual explains how to create a program, write the program using the CPU module, and debug the program. This manual is designed for first-time users of the QnACPU. It also explains some applications of the QnACPU. (sold separately)	IB-66606 (13JF10)
QnACPU PROGRAMMING MANUAL (Fundamentals) This manual describes programming methods, device names, and parameters required to create a program. It also describes various types of programs. (sold separately)	IB-66614 (13JF46)
QnACPU Programming Manual(Common Instructions) This manual explains how to use sequence instructions, basic instructions, and application instructions. (sold separately)	SH-080810ENG (13JW11)
QnACPU PROGRAMMING MANUAL (Special Function) This manual describes specific instructions for a special function module for the QnACPU. (sold separately)	SH-4013 (13JF56)
QnACPU PROGRAMMING MANUAL (AD57 Instructions) This manual describes specific instructions for controlling the AD57(S1) type CRT controller module from the QnACPU. (sold separately)	IB-66617 (13JF49)

Manual title	Manual number (Type code)
QCPU(Q mode)/QnACPU PROGRAMMING MANUAL (PID Control Instructions) This manual describes specific instructions for PID control for the QnACPU. <div style="text-align: right;">(sold separately)</div>	SH-080040 (13JF59)
QCPU(Q mode)/QnACPU PROGRAMMING MANUAL (SFC) This manual describes the system configuration, performance specifications functions, programming, debugging procedures, and the error codes of the SW0SRX-SAP3 and SW0NX-SAP3. <div style="text-align: right;">(sold separately)</div>	SH-080041 (13JF60)
Ans Module type I/O User's Manual This manual describes the specifications for the compact building block type I/O modules. <div style="text-align: right;">(sold separately)</div>	IB-66541 (13JF81)

1. SPECIFICATIONS

1.1 SPECIFICATIONS

Table 1.1 General specification

Item	Specifications					
Operating ambient temperature	0 to 55 °C					
Storage ambient temperature	-20 to 75 °C					
Operating ambient humidity	10 to 90%RH, non-condensing					
Storage ambient humidity						
Vibration resistance *4	Compliant with JIS B 3502 and IEC 61131-2		Frequency	Constant acceleration	Half amplitude	Sweep count
		Under intermittent vibration	5 to 9Hz	-	3.5mm	10 times each in X, Y, Z directions
			9 to 150Hz	9.8m/s ²	-	
		Under continuous vibration	5 to 9Hz	-	1.75mm	-
9 to 150Hz	4.9m/s ²		-			
Shock resistance	Compliant with JIS B 3502 and IEC 61131-2 (147 m/s ² , 3 times each in 3 directions X, Y, Z)					
Operating atmosphere	No corrosive gases					
Operating altitude *3	0 to 2000m					
Installation location	Inside a control panel					
Overvoltage category *1	II or less					
Pollution level *2	2 or less					
Equipment class	Class I					

- *1 This indicates the section of the power supply to which the equipment is assumed to be connected between the public electrical power distribution network and the machinery within premises.
 Category II applies to equipment for which electrical power is supplied from fixed facilities. The surge voltage withstand level for up to the rated voltage of 300V is 2500V.

- *2 This index indicates the degree to which conductive material is generated in terms of the environment in which the equipment is used. Pollution level 2 is when only non-conductive pollution occurs. A temporary conductivity caused by condensing must be expected occasionally.
- *3 Do not use or store the programmable controller under pressure higher than the atmospheric pressure of altitude 0m. Doing so may cause malfunction. When using the programmable controller under pressure, please consult your local Mitsubishi Electric representative.
- *4 When an A series extension base unit (A52B, A55B, A58B, A62B, A65B, A68B) is used in the system, the following specifications apply.

	Frequency	Acceleration	Amplitude	Sweep count
Under intermittent vibration	10 to 57Hz	-	0.075mm	10 times each in X, Y, Z directions
	57 to 150Hz	9.8m/s ²	-	
Under continuous vibration	10 to 57Hz	-	0.035mm	-
	57 to 150Hz	4.9m/s ²	-	

2. PERFORMANCE SPECIFICATION

2.1 QnASCPU Module Performance Specification

Performance specification of Q2ASCPU module is as follows:

Item		Model				Remark
		Q2ASCPU	Q2ASCPU-S1	Q2ASHCPU	Q2ASHCPU-S1	
Control method		Repetitive operation of stored program				
I/O control method		Refresh mode				I/O enabled by specifying direct I/O (DX□, DY□)
Programming language		Sequence control dedicated language				
		Relay symbol language, logic symbolic language, MELCAP3 (SFC)				
Processing speed (sequence instructions)	LD	0.2 μs/step		0.075 μs/step		
	MOV	0.6 μs/step		0.225 μs/step		
Constant scan (Function that makes scan time constant)		5 to 2000 ms (configurable in multiple of 5 ms module)				Set parameter values to specify
Memory capacity		Capacity of loading memory cards (2036 kbyte maximum)				
Program capacity	Number of steps	28 k steps maximum	60 k steps maximum	28 k steps maximum	60 k steps maximum	
	Number of files	28 files	60 files	28 files	60 files	
I/O device points		8192 points (X/Y0 to 1FFF)				Number of usable points in program
I/O points		512 points (X/Y0 to 1FF)	1024 points (X/Y0 to 3FF)	512 points (X/Y0 to 1FF)	1024 points (X/Y0 to 3FF)	Number of points accessible to actual I/O modules

Item	Model				Remark
	Q2ASCPU	Q2ASCPU-S1	Q2ASHCPU	Q2ASHCPU-S1	
Clock function	Year, month, date, hour, minute, second, day of week (auto-detects leap years) Accuracy : -1.7 to +4.9s (TYP. +1.7s) / d at 0 depress centigrade Accuracy : -1.0 to +5.2s (TYP. +2.2s) / d at 25 depress centigrade Accuracy : -7.3 to +2.5s (TYP. -1.9s) / d at 55 depress centigrade				
Allowable momentary power failure period	By power supply module				
5 VDC Internal current consumption	0.3 A	0.3 A	0.7 A	0.7 A	
Mass	0.5 kg	0.5 kg	0.5 kg	0.5 kg	
External dimension	130(H) mm × 54.5(W) mm × 110(D) mm (5.12inch × 2.15inch × 4.33inch)				

3. EMC DIRECTIVES AND LOW VOLTAGE DIRECTIVES

The products sold in the European countries have been required by law to comply with the EMC Directives and Low Voltage Directives of the EU Directives since 1996 and 1997, respectively.

The manufacturers must confirm by self-declaration that their products meet the requirements of these directives, and put the CE mark on the products.

(1) Authorized representative in Europe

Authorized representative in Europe is shown below.

Name: Mitsubishi Electric Europe BV

Address: Gothaer Strasse 8, 40880 Ratingen, Germany

3.1 Requirements for Compliance with EMC Directives

The EMC Directives specifies emission and immunity criteria and requires the products to meet both of them, i.e., not to emit excessive electromagnetic interference (emission): to be immune to electromagnetic interference outside (immunity).

Guidelines for complying the machinery including MELSEC-QnA series programmable controller with the EMC Directives are provided in Section 3.1.1 to 3.1.9 below.

The guidelines are created based on the requirements of the regulations and relevant standards, however, they do not guarantee that the machinery constructed according to them will not comply with the Directives.

Therefore, the manufacturer of the machinery must finally determine how to make it comply with the EMC Directives: if it is actually compliant with the EMC Directives.

3.1.1 EMC standards

(1) Regulations regarding emission

Standard	Test item	Test description	Value specified in standard
EN61131-2: 2007	CISPR16-2-3 Radiated emission *2	Radio waves from the product are measured.	<ul style="list-style-type: none">• 30M-230MHz QP: 40dBμV/m (10m in measurement range) *1• 230M-1000MHz QP: 47dBμV/m (10m in measurement range)
	CISPR16-2-1, CISPR16-1-2 Conducted emission *2	Noise from the product to the power line is measured.	<ul style="list-style-type: none">• 150k-500kHz QP: 79dB, Mean: 66dB *1• 500k-30MHz QP: 73dB, Mean: 60dB

*1 QP: Quasi-peak value, Mean: Average value

*2 Programmable controllers are open-type devices (devices designed to be housed inside other equipment) and must be installed inside a conductive control panel. The corresponding tests were conducted with the programmable controller installed inside a control panel.

(2) Regulations regarding immunity

Standard	Test item	Test description	Value specified in standard
EN61131-2: 2007	EN61000-4-2 Electrostatic discharge immunity *1	Immunity test in which electrostatic is applied to the cabinet of the equipment.	<ul style="list-style-type: none"> • 8kV Air discharge • 4kV Contact discharge
	EN61000-4-3 Radiated, radio-frequency, electromagnetic field immunity *1	Immunity test in which electric fields are irradiated to the product.	80% AM modulation@1kHz <ul style="list-style-type: none"> • 80M-1000MHz: 10V/m • 1.4G-2.0GHz: 3V/m • 2.0G-2.7GHz: 1V/m
	EN61000-4-4 Electrical fast transient/burst immunity *1	Immunity test in which burst noise is applied to the power line and signal line.	<ul style="list-style-type: none"> • AC/DC main power, I/O power, AC I/O (unshielded): 2kV • DC I/O, analog, communication: 1kV
	EN61000-4-5 Surge immunity *1	Immunity test in which lightning surge is applied to the power line and signal line.	<ul style="list-style-type: none"> • AC power line, AC I/O power, AC I/O (unshielded) : 2kV CM, 1kV DM • DC power line, DC I/O power : 0.5kV CM, DM • DC I/O, AC I/O (shielded), analog*2, communication : 1kV CM
	EN61000-4-6 Immunity to conducted disturbances, induced by radio-frequency fields *1	Immunity test in which high frequency noise is applied to the power line and signal line.	0.15M-80MHz, 80% AM modulation@1kHz, 10Vrms
	EN61000-4-8 Power-frequency magnetic field immunity *1	Immunity test in which the product is installed in inductive magnetic field.	50Hz/60Hz, 30A/m
	EN61000-4-11 Voltage dips and interruption immunity *1	Immunity test in which power supply voltage is momentarily interrupted.	<ul style="list-style-type: none"> • Apply at 0%, 0.5 cycles and zero-cross point • 0%, 250/300 cycles (50/60Hz) • 40%, 10/12 cycles (50/60Hz) • 70%, 25/30 cycles (50/60Hz)

*1 Programmable controllers are open-type devices (devices designed to be housed inside other equipment) and must be installed inside a conductive control panel. The corresponding tests were conducted with the programmable controller installed inside a control panel.

*2 The accuracy of an analog-digital converter module may temporarily vary within $\pm 10\%$.

3.1.2 Installation instructions for EMC Directive

The programmable controller is open equipment and must be installed within a control cabinet for use.* This not only ensures safety but also ensures effective shielding of programmable controller-generated electromagnetic noise.

* Also, each network remote station needs to be installed inside the control panel.

However, the waterproof type remote station can be installed outside the control panel.

(1) Control cabinet

- (a) Use a conductive control cabinet.
- (b) When attaching the control cabinet's top plate or base plate, mask painting and weld so that good surface contact can be made between the cabinet and plate.
- (c) To ensure good electrical contact with the control cabinet, mask the paint on the installation bolts of the inner plate in the control cabinet so that contact between surfaces can be ensured over the widest possible area.
- (d) Earth the control cabinet with a thick wire so that a low impedance connection to ground can be ensured even at high frequencies.
- (e) Holes made in the control cabinet must be 10 cm (3.94 in.) diameter or less. If the holes are 10 cm (3.94 in.) or larger, radio frequency noise may be emitted.
- (f) Lock the control panel so that only those who are trained and have acquired enough knowledge of electric facilities can open the control panel.

- (2) Connection of power and earth wires
- Earthing and power supply wires for the programmable controller system must be connected as described below.
- (a) Provide an earthing point near the power supply module. Earth the power supply's LG and FG terminals (LG: Line Ground, FG: Frame Ground) with the thickest and shortest wire possible. (The wire length must be 30 cm (11.81 in.) or shorter.) The LG and FG terminals function is to pass the noise generated in the programmable controller system to the ground, so an impedance that is as low as possible must be ensured. In addition, make sure to wire the ground cable short as the wires are used to relieve the noise, the wire itself carries large noise content and thus short wiring means that the wire is prevented from acting as an antenna.
 - (b) The earth wire led from the earthing point must be twisted with the power supply wires. By twisting with the earthing wire, noise flowing from the power supply wires can be relieved to the earthing. However, if a filter is installed on the power supply wires, the wires and the earthing wire may not need to be twisted.

3.1.3 Cables

The cables extracted from the control panel contain a high frequency noise component. On the outside of the control panel, therefore, they serve as antennas to emit noise. To prevent noise emission, use shielded cables for the cables which are connected to the I/O modules and intelligent function modules and may be extracted to the outside of the control panel.

The use of a shielded cable also increases noise resistance.

The signal lines (including common line) of the programmable controller, which are connected to I/O modules, intelligent function modules and/or extension cables, have noise durability in the condition of grounding their shields by using the shielded cables. If a shielded cable is not used or not grounded correctly, the noise resistance will not meet the specified requirements.

(1) Earthing of shielded of cables

- (a) Earth the shield of the shielded cable as near the unit as possible taking care so that the earthed cables are not induced electromagnetically by the cable to be earthed.
- (b) Take appropriate measures so that the shield section of the shielded cable from which the outer cover was partly removed for exposure is earthed to the control panel on an increased contact surface. A clamp may also be used as shown in the figure below. In this case, however, apply a cover to the painted inner wall surface of the control panel which comes in contact with the clamp.

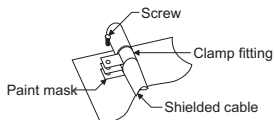

Note) The method of earthing by soldering a wire onto the shield section of the shielded cable as shown below is not recommended. The high frequency impedance will increase and the shield will be ineffective.

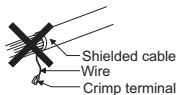

(2) MELSECNET (II) and MELSECNET/10 modules

- (a) Use a double-shielded coaxial cable for the MELSECNET module which uses coaxial cables such as A1SJ71AR21, A1SJ71LR21 and A1SJ71BR11. Noise in the range of 30 MHz or higher in radiation noise can be suppressed by the use of double-shielded coaxial cables (manufactured by MITSUBISHI CABLE INDUSTRIES, LTD: 5C-2V-CCY). Earth the outer shield to the ground

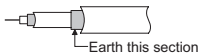

For the shield grounding, refer to item (1).

- (b) Make sure to attach a ferrite core to the double-shielded coaxial cable connected to the MELSECNET module. In addition, position the ferrite core on each cable near the outlet of the control panel. The ferrite core manufactured by TDK Corporation, ZCAT3035-1330, is recommended.

(3) Ethernet module

Precautions to be followed when AUI cables and coaxial cables are used are described below.

- (a) Always earth the AUI cables*1 connected to the 10BASE5 connectors. Because the AUI cable is of the shielded type, strip part of the outer cover and earth the exposed shield section to the ground on the widest contact surface as shown below.

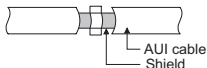

- (b) Use shielded twisted pair cables as the twisted pair cables*1 connected to the 10BASE-T connectors. For the shielded twisted pair cables, strip part of the outer cover and earth the exposed shield section to the ground on the widest contact surface as shown below.

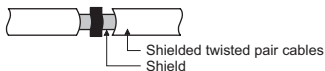

Refer to (1) for the earthing of the shield

- *1 Make sure to install a ferrite core for the cable.

The ferrite core manufactured by TDK Corporation, ZCAT2032-0930, is recommended.

- (c) Always use double-shielded coaxial cables as the coaxial cables*2 connected to the 10BASE2 connectors. Earth the double-shielded coaxial cable by connecting its outer shield to the ground.

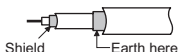

Refer to (1) for the earthing of the shield

- *2 Make sure to install a ferrite core for the cable.

The ferrite core manufactured by TDK Corporation, ZCAT3035-1330, is recommended.

Ethernet is the registered trademark of XEROX, Co.,LTD

- (4) I/O and other communication cables

For the I/O signal lines (including common line) and other communication cables (RS-232, RS-422, etc), if extracted to the outside of the control panel, also ensure to earth the shield section of these lines and cables in the same manner as in item (1) above.

(5) Positioning Modules

Precautions to be followed when the machinery conforming to the EMC Directive is configured using the A1SD75P□-S3 are described below.

(a) When wiring with a 2 m (6.56 ft.) or less cable

- Ground the shield section of the external wiring cable with the cable clamp.
(Ground the shield at the closest location to the A1SD75 external wiring connector.)
- Wire the external wiring cable to the drive unit and external device with the shortest practicable length of cable.
- Install the drive unit in the same panel.

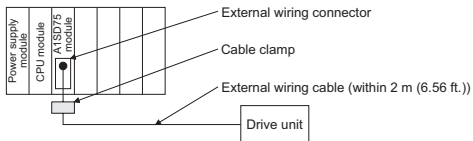

(b) When wiring with cable that exceeds 2 m (6.56 ft.), but is 10 m (32.81 ft.) or less

- Ground the shield section of the external wiring cable with the cable clamp.
(Ground the shield at the closest location to the A1SD75 external wiring connector.)
- Install a ferrite core.
- Wire the external wiring cable to the drive unit and external device with the shortest practicable length of cable.

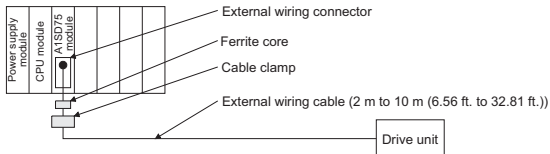

(c) Ferrite core and cable clamp types and required quantities

- Cable clamp
Type : AD75CK (manufactured by Mitsubishi Electric Corporation)
- Ferrite core
Type : ZCAT3035-1330 (manufactured by TDK Corporation)
Contact: TDK Corporation
- Required quantity

Cable length	Prepared part	Required Qty		
		1 axis	2 axes	3 axes
Within 2 m (6.56 ft.)	AD75CK	1	1	1
2 m (6.56 ft.)	AD75CK	1	1	1
to 10m (32.81 ft.)	ZCAT3035-1330	1	2	3

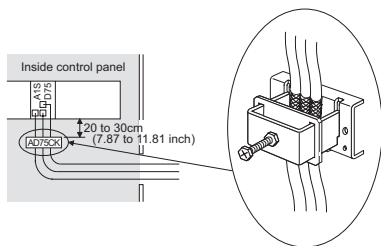

(6) CC-Link Module

- (a) Be sure to ground the cable shield that is connected to the CC-Link module close to the exit of control panel or to any of the CC-Link stations within 30 cm (11.81 in.) from the module or stations.

The CC-Link dedicated cable is a shielded cable. As shown in the illustration below, remove a portion of the outer covering and ground as large a surface area of the exposed shield part as possible.

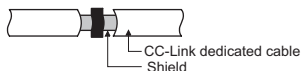

- (b) Always use the specified CC-Link dedicated cable.

- (c) The CC-Link module, the CC-Link stations and the FG line inside the control panel should be connected at the FG terminal as shown in the diagram below.

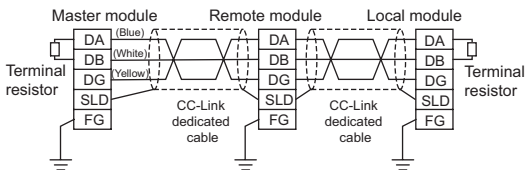

- (d) Each power line connecting to the external power supply terminal or module power supply terminal must be 30m (98.43 ft) or less.
- (e) Install a noise filter to the external power supply. Use a noise filter with an attenuation characteristic equivalent to that of the MA1206 (TDK-Lambda Corporation). Note that a noise filter is not required when the module is used in Zone A defined in EN61131-2.
- (f) Keep the length of signal cables connected to the analog input terminals of the following modules to 30m or less.
Wire cables connected to the external power supply and module power supply terminal in the control panel where the module is installed.
- AJ65BT-64RD3
 - AJ65BT-64RD4
 - AJ65BT-68TD
- (g) For the cable connected to the power supply terminal of the AJ65SBT-RPS, AJ65SBT-RPG or AJ65BT-68TD, attach a ferrite core with an attenuation characteristic equivalent to that of the ZCAT3035- 1330 from TDK Corporation. Twist the cable around the ferrite core by one as shown below.

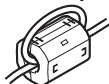

(7) CC-Link/LT module

To supply the CL2DA2-B and CL2AD4-B with 24VDC power using the CL1PAD1, keep the length of the power cable from the CL1PAD1 to the 24VDC power supply to 30m or less.

(8) Measures against static electricity

When using an insulation displacement connector without connector cover, a connected cable for the connector is thin in applicable wire size and coating. Therefore, note that the module may cause an electric discharge failure.

As measures against the failure, using pressure-displacement type connector whose applicable wire size is thick or soldering type connector is recommended.

3.1.4 Power supply module

The precautions required for each power supply module are described below. Always observe the items noted as precautions.

Mosdel	Precautions
A1S61PN, A1S62PN	Make sure to short the LG and FG terminals with a cable of 6 to 7cm and ground the cable.
A1S63P *1	Use the 24VDC panel power equipment conforming to the EU Directive.
A1SJHCPU(S8)	Make sure to short and ground the LG and FG terminals.*2

*1 Filter attachment to the power cable is not required for the A1S63P product with the version (F) and later. However, use the 24VDC panel power equipment that conforms to the CE.

*2 Make sure to attach two ferrite cores to the power line.
Attach them as close to the power supply module as possible.
Use a ferrite core whose damping characteristic is equivalent to that of the RFC-H13 produced by KITAGAWA INDUSTREIS CO., LTD.

3.1.5 Base unit

The following table shows models of base units that are compatible with EMC instructions.

Type	Model name	Applicability
Main base unit	A1S38HBEU	Applicable
	A1S3□B, A1S38HB	Not applicable
Extension base unit	A1S5□B(S1), A1S6□B(S1)	Applicable

3.1.6 Ferrite core

Use of ferrite cores is effective in reducing the conduction noise in the band of about 10 MHz and radiated noise in 30 to 100 MHz band. It is recommended to attach ferrite cores when the shield of the shielded cable coming out of the control panel does not work effectively, or when emission of the conduction noise from the power line has to be suppressed.

We tested using ferrite cores from TDK Corporation, ZCAT3035-1330 and ZCAT2032-0930, and RFC-H13 from KITAGAWA INDUSTREIS CO., LTD.

Make sure to attach a ferrite core to a cable at the position closest to the outlet of control panel as possible. If attached at an improper position, the ferrite core will not work effectively.

- Ferrite core
Type : ZCAT3035-1330, ZCAT2032-0930
Contact : TDK Corporation
Type : RFC-H13
Contact : KITAGAWA INDUSTREIS CO., LTD

3.1.7 Noise filter (power supply line filter)

TA noise filter is a component which has an effect on conducted noise. With the exception of some models, it is not required to fit the noise filter to the power supply line, but fitting it can further suppress noise. (The noise filter has the effect of reducing conducted noise of 10 M Hz or less.) Use any of the following noise filters (double π type filters) or equivalent.

Model name	FN343-3/01	FN660-6/06	ZHC2203-11
Manufacturer	SCHAFFNER	SCHAFFNER	TDK
Rated current	3 A	6 A	3 A
Rated voltage	250 V		

The precautions required when installing a noise filter are described below.

- (1) Do not bundle the wires on the input side and output side of the noise filter. When bundled, the output side noise will be induced into the input side wires from which the noise was filtered.

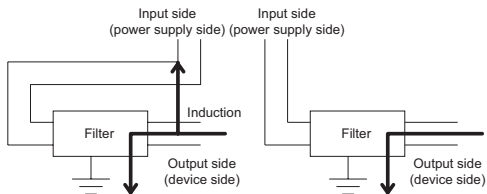

- (a) The noise will be included when the input and output wires are bundled.
 - (b) Separate and lay the input and output wires.
- (2) Earth the noise filter earthing terminal to the control cabinet with the shortest wire possible (approx. 10 cm (3.94 in.)).

3.1.8 Power line for external power supply terminal

Use a CE-marked AC/DC power supply for an external power supply of the modules, and the power cable length needs to be less than 30m (98.43 ft.).^{*1}

^{*1} The power cable length for the A1SJ71E71N-B5 needs to be less than 3m (9.84 ft.).

Install noise filters to external supply power terminals of the I/O module and the modules below.

Use noise filters whose damping characteristic is equivalent to that of the MA1206 produced by TDK Lambda Corporation.

- Analog-digital converter module
- Digital-analog converter module
- Analog I/O module
- Temperature input module
- Temperature control module
- Pulse input module
- High-speed counter module
- Positioning module

3.1.9 Installation environment of the CC-Link/LT module and the AS-i module

(1) CC-Link/LT module

Use the module under the environment of Zone A*1.

For the categories of the following products, refer to the manual came with each product.

- CL1Y4-R1B1
- CL1Y4-R1B2
- CL1XY4-DR1B2
- CL1XY8-DR1B2
- CL1PSU-2A

(2) AS-i module

Use the module under the environment of Zone A*1.

*1 Zone defines categories according to industrial environment, specified in the EMC and Low Voltage Directives, EN61131-2.

Zone C: Factory mains (isolated from public mains by dedicated transformer)

Zone B: Dedicated power distribution, secondary surge protection (rated voltage: 300V or less)

Zone A: Local power distribution, protected from dedicated power distribution by AC/DC converter and insulation transformer (rated voltage: 120V or less)

3.2 Requirements for Compliance with Low Voltage Directives

The Low Voltage Directives apply to the electrical equipment operating from 50 to 1000VAC or 75 to 1500VDC; the manufacturer must ensure the adequate safety of the equipment.

Guidelines for installation and wiring of MELSEC-QnA series programmable controller are provided in Section 3.2.1 to 3.2.7 for the purpose of compliance with the EMC Directives.

The guidelines are created based on the requirements of the regulations and relevant standards, however, they do not guarantee that the machinery constructed according to them will comply with the Directives.

Therefore, the manufacturer of the machinery must finally determine how to make it comply with the EMC Directives: if it is actually compliant with the EMC Directives.

3.2.1 Standard applied for MELSECs-QnA series programmable controller

The standard applied for MELSEC-QnA series programmable controller series is EN61010-1 safety of devices used in measurement rooms, control rooms, or laboratories.

For the modules which operate with the rated voltage of 50 VAC/75 VDC or above, we have developed new models that conform to the above standard.

For the modules which operate with the rated voltage under 50 VAC/75 VDC, the conventional models can be used, because they are out of the low voltage directive application range.

3.2.2 Precautions when using the MELSEC-QnA series programmable controller

Module selection

- (1) Power module
For a power module with rated input voltage of 100/200 VAC, select a model in which the internal part between the first order and second order is intensively insulated, because it generates hazardous voltage (voltage of 42.4 V or more at the peak) area.
For a power module with 24 VDC rated input, a conventional model can be used.
- (2) I/O module
For I/O module with rated input voltage of 100/200 VAC, select a model in which the internal area between the first order and second order is intensively insulated, because it has hazardous voltage area.
For I/O module with 24 VDC rated input, a conventional model can be used.
- (3) CPU module, memory cassette, base unit
Conventional models can be used for these modules, because they only have a 5 VDC circuit inside.
- (4) Special function module
Conventional models can be used for the special modules including analog module, network module, and positioning module, because the rated voltage is 24 VDC or smaller.
- (5) Display device
Use the CE-marked product.

3.2.3 Power supply

The insulation specification of the power module was designed assuming installation category II. Be sure to use the installation category II power supply to the programmable controller.

The installation category indicates the durability level against surge voltage generated by a thunderbolt. Category I has the lowest durability; category IV has the highest durability.

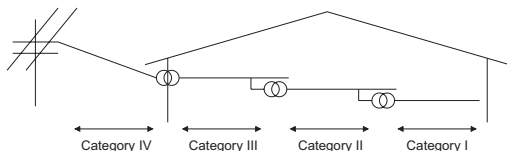

Figure 1. : Installation Category

Category II indicates a power supply whose voltage has been reduced by two or more levels of isolating transformers from the public power distribution.

3.2.4 Control panel

Because the programmable controller is an open device (a device designed to be stored within another module), be sure to use it after storing in the control panel.

(1) Electrical shock prevention

In order to prevent persons who are not familiar with the electric facility such as the operators from electric shocks, the control panel must have the following functions:

- (a) The control panel must be equipped with a lock so that only the personnel who has studied about the electric facility and have enough knowledge can open it.
- (b) The control panel must have a structure which automatically stops the power supply when the box is opened.
- (c) For electric shock protection, use IP20 or greater control panel.

(2) Dustproof and waterproof features

The control panel also has the dustproof and waterproof functions. Insufficient dustproof and waterproof features lower the insulation withstand voltage, resulting in insulation destruction. The insulation in our programmable controller is designed to cope with the pollution level 2, so use in an environment with pollution level 2 or below.

- | | |
|--------------------|---|
| Pollution level 1: | An environment where the air is dry and conductive dust does not exist. |
| Pollution level 2: | An environment where conductive dust does not usually exist, but occasional temporary conductivity occurs due to the accumulated dust. Generally, this is the level for inside the control panel equivalent to IP54 in a control room or on the floor of a typical factory. |
| Pollution level 3: | An environment where conductive dust exists and conductivity may be generated due to the accumulated dust.
An environment for a typical factory floor. |
| Pollution level 4: | Continuous conductivity may occur due to rain, snow, etc. An outdoor environment. |

As shown above, the programmable controller can realize the pollution level 2 when stored in a control panel equivalent to IP54.

3.2.5 Module installation

(1) Installing modules contiguously

In Q2AS series programmable controllers, the left side of each I/O module is left open. When installing an I/O module to the base, do not make any open slots between any two modules. If there is an open slot on the left side of a module with 100/200 VAC rating, the printed board which contains the hazardous voltage circuit becomes bare. When it is unavoidable to make an open slot, be sure to install the blank module (A1SG60).

3.2.6 Grounding

There are two kinds of grounding terminals as shown below. Either grounding terminal must be used grounded.

Be sure to ground the protective grounding for the safety reasons.

Protective grounding  : Maintains the safety of the programmable controller and improves the noise resistance.

Functional grounding  : Improves the noise resistance.

3.2.7 External wiring

- (1) Module power supply and external power supply
For the remote module which requires 24VDC as module power supply, the 5/12/24/48VDC I/O module, and the intelligent function module (special function module) which requires the external power supply, use the 5/12/24/48VDC circuit which is doubly insulated from the hazardous voltage circuit or use the power supply whose insulation is reinforced.
- (2) External devices
When a device with a hazardous voltage circuit is externally connected to the programmable controller, use a model whose circuit section of the interface to the programmable controller is intensively insulated from the hazardous voltage circuit.
- (3) Intensive insulation
Intensive insulation refers to the insulation with the dielectric withstand voltage shown in Table 1.

Table 1: Intensive Insulation Withstand Voltage
(Installation Category II, source: IEC664)

Rated voltage of hazardous voltage area	Surge withstand voltage (1.2/50 μ s)
150 VAC or below	2500 V
300 VAC or below	4000 V

4. LOADING AND INSTALLATION

4.1 Installing the Module

4.1.1 Notes on handling the module

This section explains some notes on handling the CPU module, I/O module, special function module, power supply module, and base unit.

- (1) Do not drop or allow any impact to the modules case, memory card, terminal block cover, or pin connector.
- (2) Do not remove the module printed wiring board from the case. Otherwise, a malfunction may occur.
- (3) Use caution to prevent foreign matter, such as wire chips, falling into the module during wiring. If foreign matter enters the module, remove it.
- (4) Use the following torque range to tighten the module fixing screws and terminal block screws:

Screw portion	Tightening torque range
Module fixing screw (M4 screw)	78 to 118 N·cm
I/O module (M3.5 screw)	59 to 88 N·cm
Power supply module terminal screws (M3.5 screw)	59 to 78 N·cm

- (5) Observe the following points when you are installing the DIN rail:
 - (a) Applicable DIN rail type (JIS C 2812)
TH35-7.5Fe
TH35-7.5Al
TH35-15Fe
 - (b) DIN rail installation screw interval
When you are using the TH35-7.5Fe or TH35-7.5Al DIN rail, tighten the DIN rail installation screw with a pitch of 200 mm (7.87 inch) or less to maintain the strength.

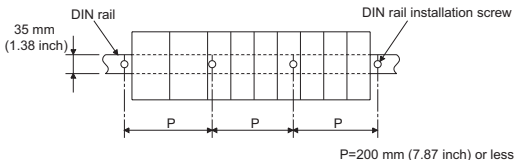

- (6) When installing the base unit to DIN rail in an environment with large vibration, use a vibration-proofing bracket (A1S-PLT-D). Mounting the vibration-proofing bracket (A1S-PLT-D) enhances the resistance to vibration.
Depending on the environment to set up the base unit, it is also recommended to fix the base unit to the control panel directly.

4.1.2 Installation environment

Avoid the following environment when you install the CPU system:

- (1) A location in which the ambient temperature falls outside the range of 0 to 55 degrees Celsius.
- (2) A location in which the ambient humidity falls outside the range of 10 to 90%RH.
- (3) A location in which condensation may occur due to drastic changes in temperature.
- (4) A location in which corrosive gas or flammable gas exists.
- (5) A location in which the system is easily exposed to conductive powder, such as dust and iron filings, oil mist, salt, or organic solvent.
- (6) A location exposed to direct sunlight.
- (7) A location in which strong electrical or magnetic fields are generated.
- (8) A location in which the module is exposed to direct vibration or impact.

4.1.3 Notes on installing the base unit

Take ease of operation, ease of maintenance, and environmental durability into consideration when you are installing the programmable controller on the panel.

(1) Mounting dimension

Mounting dimensions of each base unit are as follows:

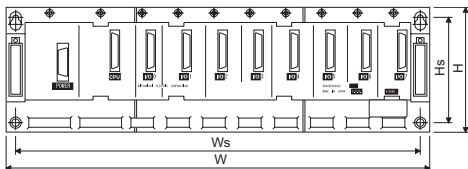

	A1S32 B	A1S33 B	A1S35 B	A1S38B A1S38HB A1S38HBE U	A1S52 B (S1)	A1S55 B (S1)	A1S58 B (S1)	A1S65 B (S1)	A1S68 B (S1)
W	220 (8.66)	255 (10.04)	325 (12.80)	430 (16.93)	155 (6.10)	260 (10.24)	365 (14.37)	315 (12.40)	420 (16.54)
Ws	200 (7.87)	235 (9.25)	305 (12.01)	410 (16.14)	135 (5.31)	240 (9.45)	345 (13.58)	295 (11.61)	400 (15.75)
H	130 (5.12)								
Hs	110 (4.33)								

Dimensions: mm (inch)

(2) Module installation position

To maintain good ventilation and make it easy to replace the module, keep the following distances between the top and bottom of the module and the structure or other components.

- A1S3□B, A1S38HB, A1S38HBEU, A1S5□B(S1), A1S6□B(S1)
..... 30 mm (1.18 inch) or over
- A5□B, A6□B..... 80 mm (3.15 inch) or over

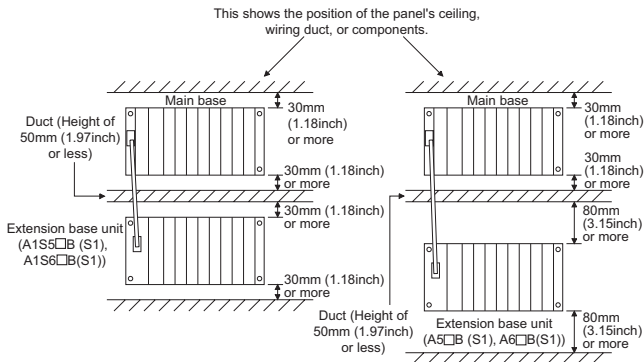

(3) Module installation direction

- (a) Use the programmable controller in the following position for better ventilation and heat dissipation:

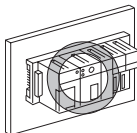

- (b) Do not use the programmable controller in the following positions:

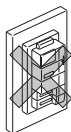

Vertical position

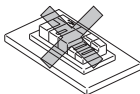

Horizontal position

- (4) Install the base unit on a level surface.
If the surface is not level, force may be applied to the printed wiring board, causing a malfunction.
- (5) Install the unit far from any source of vibration, such as a large magnetic contactor and a no-fuse breaker on the same panel, or install it on a separate panel.
- (6) Keep the following distance between the programmable controller and other devices (such as a contactor and a relay) in order to avoid the influence of radiated noise and heat:
 - a device installed in front of the programmable controller 100mm (3.94 inch) or more
 - a device installed on the right or left of the programmable controller 50mm (1.97 inch) or more

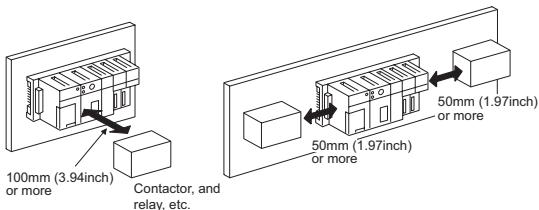

4.2 Fail-Safe Circuit Concept

When the programmable controller is powered ON and then OFF, improper outputs may be generated temporarily depending on the delay time and start-up time differences between the programmable controller power supply and the external power supply for the control target (especially, DC).

For example, if the external power supply for the control target is powered ON and then the programmable controller is powered ON, the DC output module may generate incorrect outputs temporarily upon the programmable controller power-ON. Therefore, it is required to build the circuit that energizes the programmable controller by priority.

The external power failure or programmable controller failure may lead to the system error.

In order to eliminate the possibility of the system error and ensure fail-safe operation, build the following circuit outside the programmable controller: emergency circuit, protection circuit and interlock circuit, as they could cause machine damages and accidents due to the abovementioned failures.

An example of system design, which is based on fail-safe concept, is provided on the next page.

(1) System design circuit example

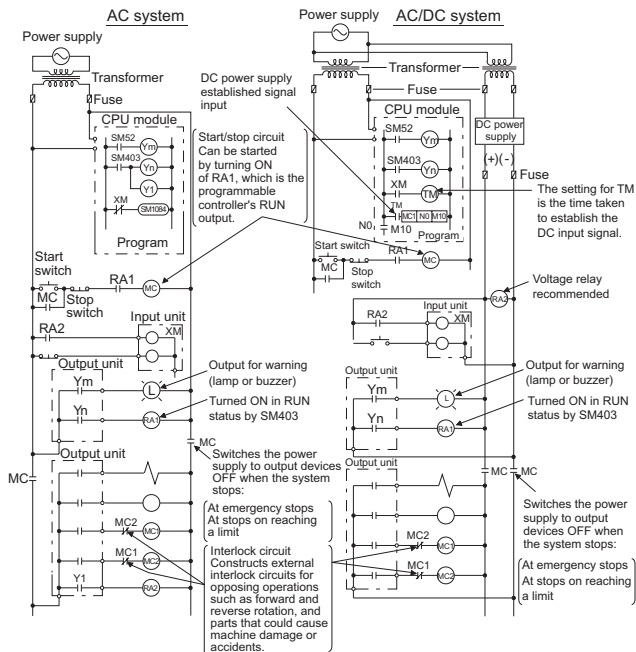

The procedures used to switch on the power supply are indicated below.

AC system

- [1] Switch the power supply ON.
- [2] Set the CPU module to RUN.
- [3] Switch the start switch ON.
- [4] The output devices are driven in accordance with program when the magnetic contactor (MC) turns ON.

AC/DC system

- [1] Switch the power supply ON.
 - [2] Set the CPU module to RUN.
 - [3] Switch RA2 ON when the DC power supply starts.
 - [4] Switch the timer (TM) ON when the DC power supply reaches working voltage. (The set value for TM must be the time it takes for 100% establishment of the DC power after RA2 is switched ON. Make this set value 0.5 seconds.)
 - [5] Switch the start switch ON.
 - [6] The output devices are driven in accordance with the program when the magnetic contactor (MC) comes ON.
- (If a voltage relay is used at RA2, no timer (TM) is necessary in the program.)

(2) Fail-safe measures to cover the possibility of programmable controller failure

Problems with a CPU module and memory can be detected by the self diagnostics function. However, problems with I/O control area may not be detected by the CPU module.

In such cases, all I/O points turn ON or OFF depending on the problem, and normal operation and safety cannot be maintained.

Though Mitsubishi programmable controllers are manufactured under strict quality control, they may fail or malfunction due to unspecified reasons. To prevent the whole system failure, machine breakdown, and accidents, build a fail-safe circuit outside the programmable controller.

Examples of a system and its fail-safe circuitry are described below:

<System example>

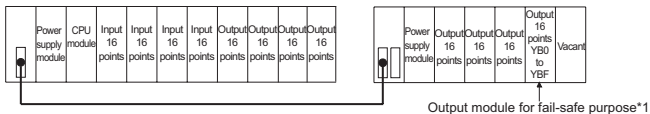

- *1 The output module for fail-safe purpose should be mounted on the last slot of the system. (YB0 to YBF in the above system.)

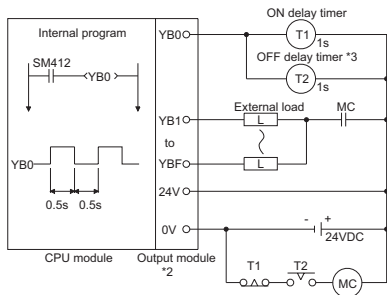

- *2 Since YB0 turns ON and OFF alternatively at 0.5 second intervals, use a contactless output module (a transistor is used in the above example).
- *3 If an offdelay timer (especially miniature timer) is not available, construct the failsafe circuit using an ondelay timer shown on the next page.

When constructing a failsafe circuit using ondelay timers only

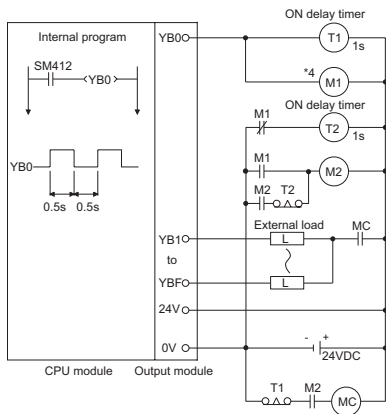

*4 Use a solid state relay for the M1 relay.

4.3 Wiring

4.3.1 Power supply module specifications

(1) Table 4.1 shows the specifications of the power supply modules.

Table 4.1 Power supply module specifications

Item	Specifications			
	A1S61PN	A1S62PN	A1S63P	
Base unit position	Power supply module slot			
Rated input voltage	100 to 240 V AC (+10 %/-15 %) (85 to 264 V AC)		24 V DC (+30 %/-35 %) (15.6 to 31.2 V DC)	
Rated input frequency	50/60 Hz \pm 5 %		-	
Input voltage distortion factor	Within 5 % (Refer to Section 4.4)		-	
Max. input apparent power	105 V A		41 W	
Inrush current	20 A 8 ms or lower *4		81 A 1 ms or lower	
Rated output current	5 V DC	5 A	3 A	5 A
	24 V DC \pm 10 %	-	0.6 A	-
Overcurrent protection *1	5 V DC	5.5 A or higher	3.3 A or higher	5.5 A or higher
	24 V DC	-	0.66 A or higher	-
Overvoltage protection *2	5 V DC	5.5 to 6.5 V		-
	24 V DC	-		-
Efficiency	65 % or higher			
Allowable momentary power failure time *3	20 ms or higher		1 ms or lower	
Dielectric withstand voltage	Between primary and 5 V DC	AC across input/LG and output/FG		500 V AC
	Between primary and 24 V DC	2830 V AC rms/3 cycle (2000 m (6562 ft.))		-
Insulation resistor	AC across input/LG and output/FG 10 M Ω or higher, measures with a 500 V DC insulation resistance tester			
Noise durability	(1) Noise voltage 1500 Vp-p, Noise width 1 μ s, Noise frequency 25 to 60 Hz (noise simulator condition) (2) Noise voltage IEC801-4, 2 kV		Noise voltage 500 Vp-p, Noise width 1 μ s, Noise frequency 25 to 60 Hz (noise simulator condition)	
Power indication	Power LED indication (light at the time of output of 5 V DC)			
Terminal screw size	M3.5 \times 7			
Applicable wire size	0.75 to 2 mm ² (AWG 18 to 14)			
Applicable solderless terminal	RAV 1.25 to 3.5, RAV 2 to 3.5			
Applicable tightening torque	59 to 88 N-cm			
External dimension	130mm \times 55mm \times 93.6mm (5.12inch \times 2.17inch \times 3.69inch)			
Weight	0.60 kg		0.50 kg	

POINT

- | | |
|----|--|
| *1 | <p>Overcurrent protection</p> <p>The overcurrent protection device shuts off the 5VDC and/or 24VDC circuit(s) and stops the system if the current exceeding the specified value flows in the circuit(s). As this results in voltage drop, the power supply module LED turns OFF or is dimly lit.</p> <p>After that, eliminate the causes of overcurrent, e.g., insufficient current capacity and short circuit, and then start the system.</p> <p>When the current has reached the normal value, the initial start up of the system will be performed.</p> |
| *2 | <p>Overvoltage protection</p> <p>The overvoltage protection shuts off the 5VDC circuit and stops the system if the overvoltage of 5.5 to 6.5V is applied to the circuit.</p> <p>This results in the power supply module LED turning OFF.</p> <p>When restarting the system, power OFF and ON the input power supply, and the initial start up of the system will be performed.</p> <p>If the system is not booted and the LED remains off, this means that the power supply module has to be replaced.</p> |
| *3 | <p>Allowable momentary power failure period</p> <p>The programmable controller CPU allowable momentary power failure period varies with the power supply module used.</p> <p>In case of the A1S63P power supply module, the allowable momentary power failure period is defined as the time from when the primary side of the stabilized power supply for supplying 24VDC to the A1S63P is turned OFF until when the voltage (secondary side) has dropped from 24VDC to the specified value (15.6VDC) or less.</p> |
| *4 | <p>Inrush current</p> <p>If the power supply module is re-powered ON right after powered OFF (within 5seconds), the inrush current exceeding the specified value (2ms or less) may be generated. Therefore, make sure to re-power ON the module 5seconds after power off.</p> <p>When selecting a fuse or breaker for external circuit, consider the above point as well as meltdown and detection characteristics.</p> |

4.3.2 Parts names

The following gives the names and description of the parts of the power supply modules:

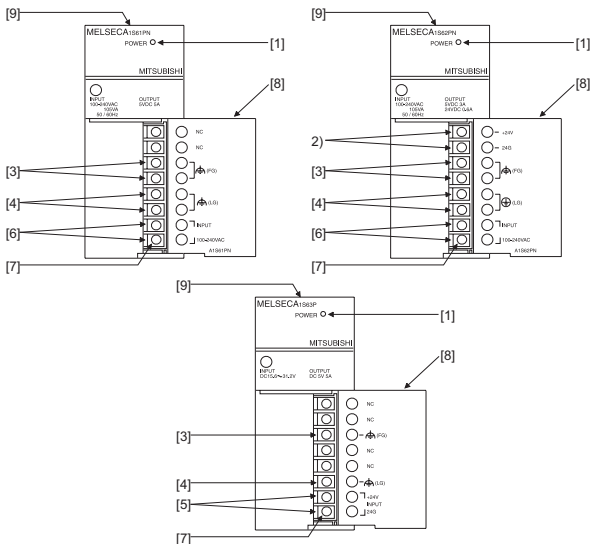

No.	Name	Description
[1]	POWER LED	The indicator LED for the 5 V DC power.
[2]	24 V and 24 G terminals	Used to supply 24 V DC to inside the output module (using external wiring).
[3]	FG terminal	The grounding terminal connected to the shield pattern of the printed circuit board.
[4]	LG terminal	Grounding for the power supply filter. The potential of A1S61PN or A1S62PN terminal is 1/2 of the input voltage.
[5]	Power supply input terminals	Used to connect a 24 V DC power supply.
[6]	Power supply input terminals	Used to connect 100 V AC to 200 V AC power supply.
[7]	Terminal screw	M3.5 × 7
[8]	Terminal cover	The protective cover of the terminal block.
[9]	Module fixing screw	Used to fix the module to the base unit. (M4 screw, tightening torque: 78 to 118 N·cm)

POINT

- (1) Do not cable to the unused terminals such as FG and LG on the terminal block (terminals whose name is not printed on the terminal cover).
- (2) Be sure to ground the terminal \oplus LG to the protective ground conductor with class D (class-3) grounding or above.

4.3.3 Wiring instructions

Instructions for wiring the power supply cable and I/O cable.

(1) Wiring of power supply

- (a) When voltage fluctuations are larger than the specified value, connect a constant-voltage transformer.

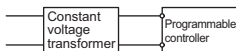

- (b) Use a power supply which generates minimal noise between wires and between the programmable controller and ground. If excessive noise is generated, connect an insulating transformer.

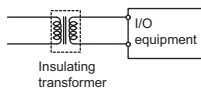
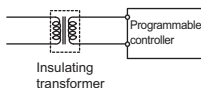

- (c) When a power transformer or insulating transformer is employed to reduce the voltage from 200 VAC to 100 VAC, use one with a capacity greater than those indicated in the following table.

Power Supply Module	Transformer Capacity
A1S61PN	110VA × n
A1S62PN	110VA × n

n: Stands for the number of power supply modules.

- (d) Separate the programmable controller's power supply line from the lines for I/O devices and power devices as shown below.

When there is much noise, connect an insulation transformer.

- (e) Taking rated current or inrush current into consideration when wiring the power supply, be sure to connect a breaker or an external fuse that have proper blown and detection. When using a single programmable controller, a 10A breaker or an external fuse are recommended for wiring protection.

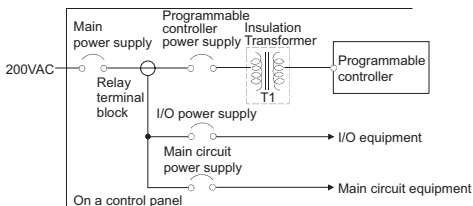

- (f) Note on using the 24 VDC output of the A1S62PN power supply module.

CAUTION ● Do not connect multiple power supply modules to one module in parallel. The power supply modules may be heated, resulting in a fire or failure.

If the 24 VDC output capacity is insufficient for one power supply module, supply 24 VDC from the external 24 VDC power supply as shown below:

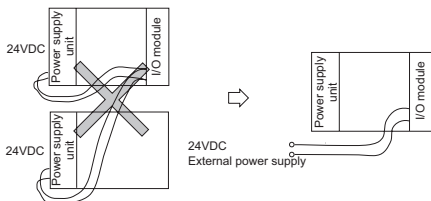

- (g) 100 V AC, 200 V AC and 24 V DC wires should be twisted as dense as possible. Connect the modules with the shortest distance. Also, to reduce the voltage drop to the minimum, use the thickest wires possible (maximum 2mm²).
- (h) Do not bind 100VAC and 24VDC wires together with main circuit (high tension and large current) wires or I/O signal wires (including common line) nor place them near each other. Provide 100mm (3.94 inch) clearance between the wires if possible.

- (i) As a countermeasure to power surge due to lightning, connect a surge absorber for lightning as shown below.

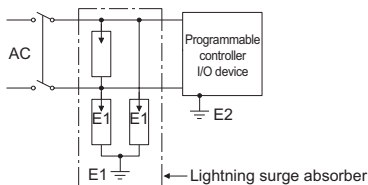

POINT

- (1) Separate the ground of the surge absorber for lightning (E1) from that of the programmable controller (E2).
- (2) Select a surge absorber for lightning whose power supply voltage does not exceed the maximum allowable circuit voltage even at the time of maximum power supply voltage elevation.

(2) Wiring to I/O device

- (a) The solderless terminal with insulation sleeve is inapplicable to a terminal block.
It is advisable to cover the wire connection part of a terminal with a mark tube or insulation tube.
- (b) Install wiring to a terminal block using the cable of core diameter 0.3 to 0.75mm², and outside diameter 2.8mm or less.
- (c) Run the I/O line and output line away from each other.
- (d) When the main circuit line and power line cannot be separated, use a shielding cable and ground it on the programmable controller side.
However, ground it on the opposite side in some cases.

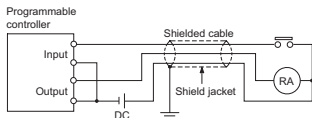

- (e) When cables are run through pipes, securely ground the pipes.
- (f) Run the 24VDC input line away from the 100VAC and 200 VAC lines.

- (g) The cabling of 200m (656.2ft.) or longer distance may produce leakage current depending on the capacity between lines and result in an accident.
- (h) As a countermeasure against the power surge due to lightning, separate the AC wiring and DC wiring and connect a surge absorber for lightning as shown in (i) of item (1). Failure to do so increases the risk of I/O device failure due to lightning.

(3) Grounding

- (a) Carry out the independent grounding if possible. (Grounding resistance 100Ω or less.)
- (b) If the independent grounding is impossible, carry out the shared grounding (2) as shown below.

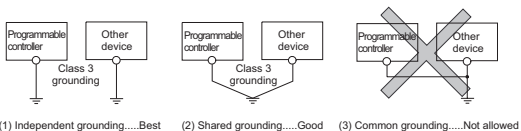

- (c) Use the cable of 2mm² or more for grounding.
Set the grounding point closer to the programmable controller to make the grounding cable short as possible.
- (d) If a malfunction occurs due to earthing, separate either LG or FG of the base module, the device combination, or all the connection from the earthing.

4.3.4 Wiring to module terminals

This section explains the wiring of power lines and grounding lines to the main and extension bases.

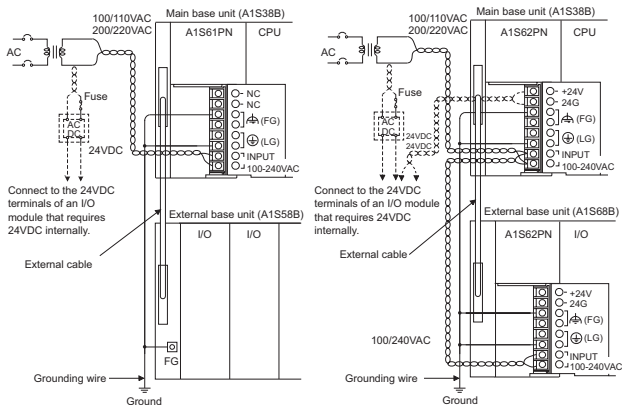

POINT

- (1) Use the thickest possible (max. 2 mm² (14 AWG)) wires for the 100/200 VAC and 24 VDC power cables. Be sure to twist these wires starting at the connection terminals. For wiring a terminal block, be sure to use a solderless terminal. To prevent short-circuit due to loosening screws, use the solderless terminals with insulation sleeves of 0.8 mm (0.03 inch) or less thick. The number of the solderless terminals to be connected for one terminal block are limited to 2.

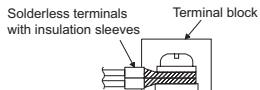

- (2) Be sure to ground the LG and FG terminals. Failure to do so may cause the programmable controller to be susceptible to noise. Note that LG terminals include the potential as half as that of input voltage; you might get an electric shock when you touch them.
- (3) A1S61PN and A1S62PN do not need to be switched as they are 100 to 240VAC wide-range.

4.4 Precautions when Connecting the Uninterruptible Power Supply (UPS)

Connect the Q2ASCPU system to the uninterruptible power supply (UPS), while paying attention to the followings.

When connecting an uninterruptible power supply (UPS) to the programmable controller system, use an online UPS or line-interactive UPS with a voltage distortion rate of 5% or less.

When connecting a standby UPS, use a Mitsubishi FREQUPS FW-F series UPS (hereinafter FW-F series UPS)*1. (Example: FW-F10-0.3K/0.5K)

Do not use any standby UPS other than the FW-F series UPS.

- *1 The FW-F series UPS whose serial number starts with the letter "P" or later, or ends with the letters "HE" is applicable.

SERIAL : 000000000
 ↑
 └────────── Starts with "P" or later

SERIAL : B00000000 HE
 ↑
 └── Ends with "HE"

4.5 Part names and Settings

4.5.1 Part names and settings

This section describes the name and setting of each part of the module.

Q2ASCPU, Q2ASCPU-S1, Q2ASHCPU, Q2ASHCPU-S1

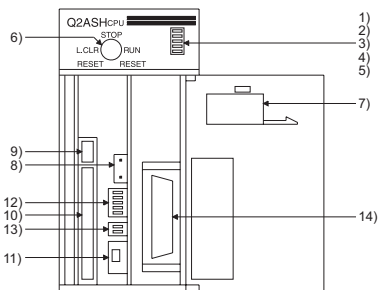





Illustration of the module with the front cover open

No.	Name	Application
1)	RUN LED	<p>This LED indicates the CPU module operating condition.</p> <p>Lit : Operating with the RUN/STOP key switch set to RUN or STEP-RUN.</p> <p>Off : Stopped with the RUN/STOP key switch set to STOP, PAUSE, or STEP-RUN. Or, the CPU module has detected the error that would cause the operation to stop.</p> <p>Flash : The RUN/STOP key switch has been set from STOP to RUN after the program was written in stop mode. The CPU module is not in RUN mode. To engage the CPU module in RUN mode, set the RUN/STOP key switch to RUN, STOP, the RUN. Alternatively, reset the module using the RUN/STOP key switch.</p>
2)	ERROR LED	<p>Lit : A self-diagnostic error (other than a battery error) that will not stop operation has been detected. (The parameter has been set to Continue operation at error detection.)</p> <p>Off : Normal</p> <p>Flash : An error that will stop the operation has been detected.</p>
3)	USER LED	<p>Lit : A error has been detected by the CHK instruction, or annunciator F has been turned ON.</p> <p>Off : Normal</p> <p>Flash : The latch clear operation has been executed.</p>
4)	BAT. ALARM LED	<p>Lit : Battery error has occurred due to a drop in the CPU module main unit/memory card battery voltage.</p> <p>Off : Normal</p>

No.	Name	Application																								
5)	BOOT LED	Lit : The boot operation has been completed. Off : The boot operation has not been executed.																								
6)	RUN/STOP key switch	RUN/STOP : Executes/stops the operation of the sequence program. L.CLR : Sets the entire data of the latch area specified by the parameter to OFF or 0. Clears the entry of the sampling trace and the status latch. RESET : Executes the hardware reset operation and the reset at an operation error occurrence, and initializes the operation.																								
7)	Battery (A6BAT)	Backup battery to be used for the internal RAM and the power failure compensation function.																								
8)	Battery connector pin	Used to connect the battery lead wire. (The lead wire is removed from the connector at shipment in order to prevent battery consumption.)																								
9)	Memory card EJECT button	Used to eject the memory card from the CPU module.																								
10)	Memory card loading connector	This connector is used to load the memory card in the CPU module.																								
11)	Memory card Load/eject switch (LED equipped) 	This switch setting determines whether or not you can load/eject the memory card during energizing. The factory default setting is OFF. ON : Loading is prohibited. (LED is lit.) OFF : Loading is allowed. (LED is turned off.)																								
12)	System setting switches 1 	<p>These switches allow you to set the items for the CPU module operation. The factory default setting of all switches is OFF.</p> <p>SW5 : Boot setting. This switch allows you to select the memory for operation. ON : Boot operation OFF : Boot operation is not performed</p> <p>SW2 to 4 : Parameter area. These switches allow you to select the memory into which to write the parameters.</p> <table border="1" data-bbox="288 968 637 1103"> <thead> <tr> <th rowspan="2"></th> <th rowspan="2">Internal RAM</th> <th colspan="2">Memory card</th> <th rowspan="2"></th> </tr> <tr> <th>RAM</th> <th>ROM</th> </tr> </thead> <tbody> <tr> <td>SW4</td> <td>OFF</td> <td>ON</td> <td>OFF</td> <td rowspan="4">*SW2 to 4 are valid if SW5 is OFF.</td> </tr> <tr> <td>SW3</td> <td>OFF</td> <td>OFF</td> <td>ON</td> </tr> <tr> <td>SW2</td> <td>OFF</td> <td>OFF</td> <td>OFF</td> </tr> <tr> <td>SW1</td> <td colspan="3">SW1 : System protect. Writing to the CPU module and issuing the control instructions are prohibited. ON : System protect is valid. OFF : System protect is invalid.</td> </tr> </tbody> </table>		Internal RAM	Memory card			RAM	ROM	SW4	OFF	ON	OFF	*SW2 to 4 are valid if SW5 is OFF.	SW3	OFF	OFF	ON	SW2	OFF	OFF	OFF	SW1	SW1 : System protect. Writing to the CPU module and issuing the control instructions are prohibited. ON : System protect is valid. OFF : System protect is invalid.		
	Internal RAM	Memory card																								
		RAM	ROM																							
SW4	OFF	ON	OFF	*SW2 to 4 are valid if SW5 is OFF.																						
SW3	OFF	OFF	ON																							
SW2	OFF	OFF	OFF																							
SW1	SW1 : System protect. Writing to the CPU module and issuing the control instructions are prohibited. ON : System protect is valid. OFF : System protect is invalid.																									

No.	Name	Application
13)	System setting switches 2 	<p>These switches allow you to set the items for CPU module operation. The factory default setting of all switches is OFF.</p> <p>SW2 : Unused (Fixed to OFF)</p> <p>SW1 : Peripheral protocol. This switch allows you to select the type of peripheral devices that are connected to the CPU module peripheral interface. (Set this switch to ON when you wish to access another stations ACPU from the ACPU peripheral device. The setting becomes effective as soon as you set the switch.)</p> <p>ON : Peripheral device for the ACPU OFF : Peripheral device for the Q2ASCPU</p>
14)	RS-422 connector	Used to connect a peripheral device.

4.5.2 Relation between switch operation and the LED indication

- (1) Writing a program while the CPU module is stopped:
Follow the procedure below to write a program while the CPU module is stopped:
 - 1) RUN/STOP key switch: STOP
RUN LED: Off..... CPU module is in STOP mode.
→ Write a program.
 - 2) RUN/STOP key switch: RESET
RUN LED: Off..... CPU module is in STOP mode.
 - 3) RUN/STOP key switch: STOP → RUN
RUN LED: Lit..... CPU module is in RUN mode.

POINT
<ul style="list-style-type: none">● After writing a program (except for online program write), perform reset operation, and then place the CPU module in the RUN status.● When remote STOP is switched to RUN, the CPU module is not put in the "PROG CHECK" status but is placed in the RUN status.

- (2) Latch clear operation:
Operate the RUN/STOP key switch as follows to execute the latch clear operation:
 - 1) Turn the RUN/STOP key switch of the CPU module from the "STOP" position to the "L. CLR" position several times (three or four times) to flicker the "USER LED" on the CPU module front. Normally, the LED flickers when the switch is turned several times (three or four times).
When the "USER LED" flickers, it indicates that latch clear is ready.
 - 2) After the "USER LED" has flickered, turning the RUN/STOP key switch from the "STOP" position to the "L. CLR" position again executes latch clear and lights up the "USER LED".
If the "USER LED" comes on for two seconds and then goes off, it indicates that latch clear is completed normally.
 - 3) To cancel latch clear midway, turn the RUN/STOP key switch to the "RUN" position to place the CPU module in the RUN state, or turn it to the "RESET" position to make a reset.

POINT

- You can make latch clear valid or invalid for each device via the device setting in parameter mode.
- Instead of using the RUN/STOP key switch, you can also execute the latch clear operation remotely from the peripheral device. (Refer to the Q2AS(H)CPU(S1) User's Manual)

- (3) Removing the memory card while the programmable controller power is on:
Operate the memory card load/eject switch as described below the memory card while the programmable controller power is still on:
- 1) Load/eject switch: ON,
Load/eject switch internal LED: Lit..... Ejecting the memory card is prohibited.
 - 2) Load/eject switch: OFF,
Load/eject switch internal LED: Off..... Ejecting the memory card is allowed.
..... → Remove the memory card.

POINT

- The load/eject switch internal LED may not be turned off when you are using the memory card for the CPU module system function (such as sampling trace and status latch) or for the program.
In this case, quit the corresponding system function or program that is using the memory card. Then, make sure that the load/eject switch internal LED is turned off, and remove the memory card.
- Do not turn on the memory card load/eject switch after you have removed the memory card. Otherwise, an error will occur.
- When there are parameter-set file registers, local devices or failure history, the memory card cannot be removed.
If the "memory card in/out" switch is turned OFF, the in/out switch built-in LED does not go off.
For the file registers, the memory card can be removed when they are set to be unused with the QDRSET(P) instruction.

- (4) Loading the memory card while the programmable controller power is on:

Operate the memory card load/eject switch as described below to load the memory card while the programmable controller power is still on:

- 1) Load the memory card.
- 2) Load/eject switch: ON,
Load/eject switch internal LED: Lit..... Ejecting the memory card is prohibited.

POINT

- | |
|--|
| <ul style="list-style-type: none">● Be sure to turn on the memory card load/eject switch after you have loaded the memory card. Otherwise, you will not be able to use the card.● Since mount processing is performed again after the memory card is inserted, note that the scan time of one scan when mount processing is performed increases by a maximum of 10ms. |
|--|

5. SPECIFICATION AND CONNECTION OF I/O MODULES

5.1 Input modules

5.1.1 Input module specifications

Model	Type	No. of Points	Rated Input Voltage	Input Current	Operating Voltage	
					ON voltage	OFF voltage
A1SX10	AC input	16	100 to 120VAC	6mA	80VAC or higher	30VAC or lower
A1SX10EU				7mA		
A1SX20			200 to 240VAC	9mA		
A1SX20EU				11mA		
A1SX30	DC/AC input		12/24VDC	4.2/8.6mA	7VDC/AC or higher	2.7VDC/AC or lower
			12/24VAC			
A1SX40	DC input (sink type)		12/24VDC	3/7mA	8VDC or higher	4VDC or lower
A1SX40-S1			24VDC	7mA	14VDC or higher	6.5VDC or lower
A1SX40-S2						
A1SX41		32	12/24VDC	3/7mA	8VDC or higher	4VDC or lower
A1SX41-S1			24VDC	7mA	17VDC or higher	3.5VDC or lower
A1SX41-S2					14VDC or higher	6.5VDC or lower
A1SX42	64	12/24VDC	2/5mA	8VDC or higher	4VDC or lower	
A1SX42-S1		24VDC	5mA	18.5VDC or higher	3VDC or lower	
A1SX42-S2				17.5VDC or higher	7VDC or lower	

	Maximum Simultaneous Input Points (Percentage Simultaneously ON)	Max. Response Time		Field Wiring	Points/ Common	Internal Current Consumption (5VDC)	No. of Occupied Points
		OFF to ON	ON to OFF				
	100%(110VAC)	20ms or lower	35ms or lower	Terminal	16	0.05A	16
	60%(132VAC)						
	100%(110VAC)						
	60%(220VAC)	30ms or lower	55ms or lower				
	75%(26.4VDC)	20ms or lower	20ms or lower				
		25ms or lower	20ms or lower				
	100%(26.4VDC)	10ms or lower	10ms or lower				
		0.1ms or lower	0.2ms or lower				
	60%(26.4VDC)	10ms or lower	10ms or lower	40-pin connector	32	0.08A	32
		0.3ms or lower	0.3ms or lower			0.12A	
		10ms or lower	10ms or lower			0.08A	
	50%(24VDC)	10ms or lower	10ms or lower	40-pin connector ×2		0.09A	64
		0.3ms or lower	0.3ms or lower			0.16A	
		10ms or lower	10ms or lower			0.09A	

Model	Type	No. of Points	Rated Input Voltage	Input Current	Operating Voltage		
					ON voltage	OFF voltage	
A1SX71	DC input (sink/source type)	32	5/12/24VDC	1.2/3.3/7mA	3.5VDC or higher	1VDC or lower	
A1SX80		16	12/24VDC	3/7mA	8VDC or higher	4VDC or lower	
A1SX80-S1			24VDC	7mA	17VDC or higher	5VDC or lower	
A1SX80-S2			24VDC		13VDC or higher	6VDC or lower	
A1SX81			32	12/24VDC	3/7mA	8VDC or higher	4VDC or lower
A1SX81-S2		24VDC		7mA	13VDC or higher	6VDC or lower	
A1SX82-S1		64	24VDC	5mA	18.5VDC or higher	3VDC or lower	
A1S42X		DC input (dynamic)	*2 16/32 48/64	12/24VDC	4/9mA	8VDC or higher	4VDC or lower

	Maximum Simultaneous Input Points (Percentage Simultaneously ON)	Max. Response Time		Field Wiring	Points/ Common	Internal Current Consumption (5VDC)	No. of Occupied Points
		OFF to ON	ON to OFF				
	65%(24VDC)	1.5ms or lower	3ms or lower	40-pin connector	32	0.075A	32
	100%(26.4VDC)	10ms or lower	10ms or lower	Terminal	16	0.05A	16
	85%(26.4VDC)	0.4ms or lower	0.5ms or lower				
	100%(26.4VDC)	10ms or lower	10ms or lower				
	60%(26.4VDC)	10ms or lower	10ms or lower	37-pin D-sub connector	32	0.08A	32
	50%(26.4VDC)	0.3ms or lower	0.3ms or lower	40-pin connector ×2	32	0.16A	64
	100%(26.4VDC)	0.4ms or lower*1	0.4ms or lower*1	24-pin connector	-	0.08A	16/32/48/64

For all modules, the insulation system is photocoupler insulation and the input indications are LED indications.

*1.....The dynamic scan cycle is 13.3ms.

*2.....Set using the DIP switch on the module front.

5.1.2 Input module connections

	Model	Rated Input Voltage
(1)	A1SX10	100 to 120 VAC
	A1SX10EU	
	A1SX20	200 to 240 VAC
	A1SX20EU	

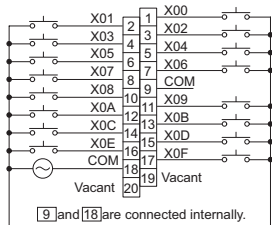

(2)	Model	Rated Input Voltage
	A1SX30	12/24 VDC 12/24 VAC

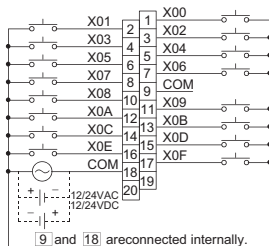

WARNING

- Do not touch terminals while the power is supplied.

	Model	Rated Input Voltage
(3)	A1SX40	12/24 VAC
	A1SX40-S1	24 VAC
	A1SX40-S2	

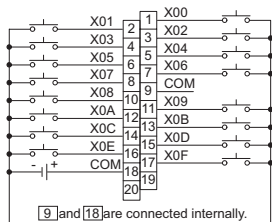

	Model	Rated Input Voltage
(4)	A1SX80	12/24 VAC
	A1SX80-S1	24 VAC
	A1SX80-S2	

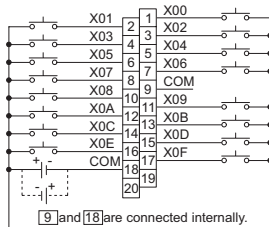

	Model	Rated Input Voltage
(5)	A1SX41	12/24 VDC
	A1SX41-S1(S2)	24 VDC
	A1SX42	12/24 VDC
	A1SX42-S1(S2)	24 VDC
	A1SX82-S1 ^{*3}	

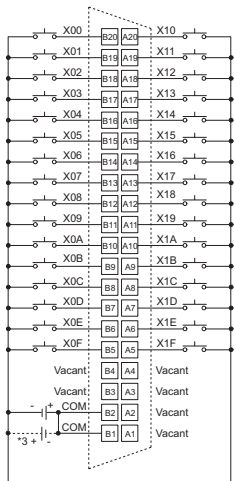

- *1 The figure above indicates **F** (the first half 32 points). The connections for **L** (the latter half 32 points) are the same as for **F** (regard X00 to X1F as X20 to X3F.) **B1** and **B2**, and **A1** and **A2**, are connected internally.
- *2 The A and B pin number rows shown above are transposed with respect to the diagram of the A and B rows which is printed on the module. Remember that the A row pin numbers correspond to the B row of the module.
- *3 A1SX82-S1 can use both positive common and negative common.

(6)	Model	Rated Input Voltage
	A1SX71	5/24 VDC

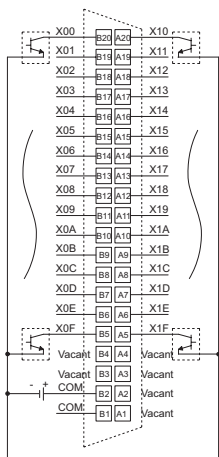

- *1 The figure above shows the connections for the open collector (sink) type. **B1** and **B2** are connected internally.

- TTL, LS-TTL, CMOS buffer (sink) connection

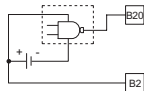

- Sensor (source) connection

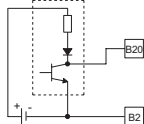

- *2 The A and B pin number rows shown above are transposed with respect to the diagram of the A and B rows which is printed on the module. Remember that the A row pin numbers correspond to the B row of the module.

	Model	Rated Input Voltage
(7)	A1SX81	12/24 VDC
	A1SX81-S2	24 VDC

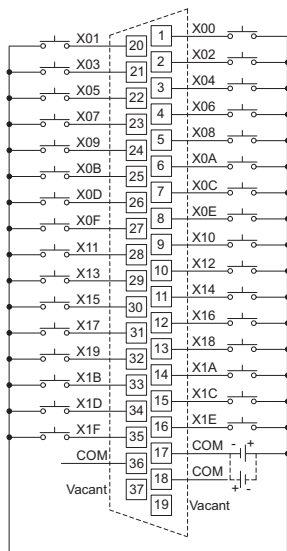

- **17**, **18** and **36**, are connected internally.

(8)	Model	Rated Input Voltage
	A1S42X	12/24 VDC

Pin Arrangement

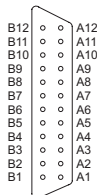

Seen from front face of the module

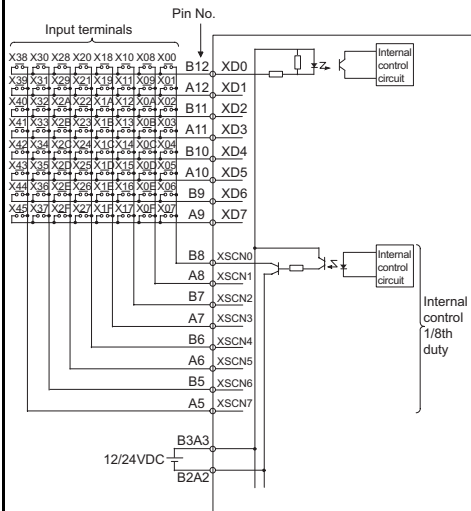

* If there will be cases where two or more switches are pressed simultaneously, install a diode at each switch (see right).



Pin No.	Signal Name	Pin No.	Signal Name
B12	XD0	A12	XD1
B11	XD2	A11	XD3
B10	XD4	A10	XD5
B9	XD6	A9	XD7
B8	XSCN 0	A8	XSCN 1
B7	XSCN 2	A7	XSCN 3
B6	XSCN 4	A6	XSCN 5
B5	XSCN 6	A5	XSCN 7
B4	Vacant	A4	Vacant
B3	12/24 VDC	A3	12/24 VDC
B2	0V	A2	0V
B1	FG	A1	FG

5.2 Output modules

5.2.1 Output module specifications

Model	Type	No. of Points	Rated Load Voltage	Max. Load Current			Max. Output Response Time	
				Point	Common	Module	OFF to ON	ON to OFF
A1SY10	Relay Output	16	100V to 240VAC 24VDC	2A	8A	-	10ms or lower	12ms or lower
A1SY10EU		16	AC100V to 120V DC24V	2A	8A	-		
A1SY14EU		12	100V to 240VAC 24VDC	2A	8A	-		
A1SY18A		8		2A	-	8A		
A1SY18AEU		8		2A	-	-		
A1SY22	Triac Output	16	100V to 240VAC	0.6A	2.4A	-	1ms or lower	1ms + 0.5 cycles or less
A1SY28A		8		1A	-	8A (AC136V, 46°C) 8A (AC264V, 40°C) 4A (AC132V, 55°C) 2A (AC264V, 55°C)		

For all modules, the insulation system is photocoupler insulation and the output indications are LED indications.

*1..... The dynamic scan cycle is 13.3ms (FAST mode) or 106.7ms (SLOW mode).

(Set using the DIP switch on the module rear.)

*2..... Set using the DIP switch on the module front.

	Field Wiring	Points/ Common	Surge Suppression	Fuse Rating	Error display	External Power Supply (TYP DC24V)	Internal Current Consumption	No. of Occupied Points
						Current		
		8	None	None	None	0.090A	0.12A	16
		8				0.090A	0.12A	
		4				0.1A	0.12A	
		-				0.075A	0.24A	
		-				0.075A	0.24A	
		8	CR absorber	5A	LED *5	0.002A *3	0.27A	
	-	CR absorber varistor	None	None	-	0.13A		

*3.....Value at TYP 200VAC.

*4.....Value at TYP 12VDC.

*5....."ERR".LED turns on when fuse is blown or external supply power is off.

*6.....0.08A is shown on the rating plate of the module.

*7.....0.15A is shown on the rating plate of the module.

Model	Type	No. of Points	Rated Load Voltage	Max. Load Current			Max. Output Response Time	
				Point	Common	Module	OFF to ON	ON to OFF
A1SY28EU	Triac Output	8	100V to 240VAC	0.6A	2.4A (46°C) 1.9A (55°C)	-	1ms or lower	1ms + 0.5 cycles or less
A1SY40	Transistor Output (sink type)	16	12/24VDC	0.1A	0.8A	-	2ms or lower	2ms or lower
A1SY40P					0.8A	-	1ms or lower	1ms or lower
A1SY41		32		0.1A	2A	-	2ms or lower	2ms or lower
A1SY41P					2A	-	1ms or lower	1ms or lower
A1SY42		64		0.1A	1.6A	-	2ms or lower	2ms or lower
A1SY42P					2A	-	1ms or lower	1ms or lower
A1SY50		16		0.5A	2A	-	2ms or lower	2ms or lower
A1SY60	2A (28°C) 1.8A (45°C) 1.6A (55°C)		4A (28°C) 3.6A (45°C) 3.2A (55°C)					
A1SY60E	Transistor Output (source type)	5/12/24VDC	2A	4A	-	3ms or lower	10ms or lower	
A1SY68A	Transistor Output (sink/source type)	8	5/12/24/48VDC	2A	-			

For all modules, the insulation system is photocoupler insulation and the output indications are LED indications.

*1..... The dynamic scan cycle is 13.3ms (FAST mode) or 106.7ms (SLOW mode).

(Set using the DIP switch on the module rear.)

*2..... Set using the DIP switch on the module front.

	Field Wiring	Points/ Common	Surge Suppression	Fuse Rating	Error display	External Power Supply (TYP DC24V)	Internal Current Consumption	No. of Occupied Points
						Current		
	Terminal	4	CR absorber	None	None	-	0.27A	16
		8				Zener diode	1.6A	
	40-pin connector	32	Zener diode	3.2A	LED *5		0.008A	0.5A
				40-pin connector ×2	3.2A	LED *5	0.008A	0.93A
	Terminal	8	Zener diode		None	LED *5	0.014A	0.17A
				3.2A	0.06A		0.12A	
				5A	0.015A		0.12A	
				7A	0.01A		0.2A	
		-		None	None	-	0.11A	

*3.....Value at TYP 200VAC.

*4.....Value at TYP 12VDC.

*5....."ERR".LED turns on when fuse is blown or external supply power is off.

*6.....0.08A is shown on the rating plate of the module.

*7.....0.15A is shown on the rating plate of the module.

Model	Type	No. of Points	Rated Load Voltage	Max. Load Current			Max. Output Response Time	
				Point	Common	Module	OFF to ON	ON to OFF
A1SY71	Transistor Output (for TTL/CMOS) sink type	32	5/ 12VDC	0.016A	0.256A	-	1ms or lower	1ms or lower
A1SY80	Transistor Output (source type)	16	12/ 24VDC	0.8A	3.2A	-	2ms or lower	2ms or lower
A1SY81				0.1A	2A	-		
A1SY81EP		32		0.1A (25°C) 0.05A (55°C)	2A (25°C) 1.6A (55°C)	-	0.5ms or lower	1.5ms or lower
A1SY82		64		12VDC 0.1A	12VDC 1.6A	-	2ms or lower	2ms or lower
				24VDC 0.05A	12VDC 1.6Av			
A1S42Y	Transistor Output (dynamic)	16/32 48/64 *2		0.1A (40°C) 0.05A (55°C)	-	-	2ms or lower *1	2ms or lower *1

For all modules, the insulation system is photocoupler insulation and the output indications are LED indications.

*1..... The dynamic scan cycle is 13.3ms (FAST mode) or 106.7ms (SLOW mode).

(Set using the DIP switch on the module rear.)

*2..... Set using the DIP switch on the module front.

	Field Wiring	Points/ Common	Surge Suppression	Fuse Rating	Error display	External Power Supply (TYP DC24V)	Internal Current Consumption	No. of Occupied Points
						Current		
	40-pin connector	32	None	1.6A	LED *5	0.15A *4	0.4A	32
	Terminal	8	Zener diode	5A		0.02A	0.12A	16
	37-pin D-sub connector	32		3.2A	None	0.008A	0.5A	32
			Clamp diode	None		None	0.080A	
	40-pin connector *2	32	Zener diode	3.2A	LED *5	0.080A	0.93A	64
	24-pin connector	-	None	1.6A	LED *5	0.008A	0.1A	16/32 48/64

*3.....Value at TYP 200VAC.

*4.....Value at TYP 12VDC.

*5....."ERR".LED turns on when fuse is blown or external supply power is off.

*6.....0.08A is shown on the rating plate of the module.

*7.....0.15A is shown on the rating plate of the module.

5.2.2 Output module connections

(1)	Model	Rated Load Voltage
	A1SY10	24 VDC, 100 to 240 VDC

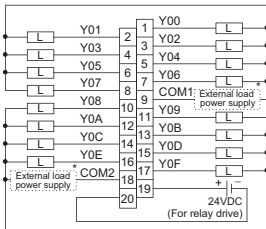

*: The external load power supply section is as shown below.

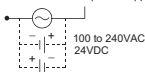

(2)	Model	Rated Load Voltage
	A1SY10EU	24 VDC, 100 to 240 VDC

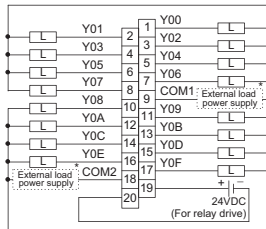

*: The external load power supply section is as shown below.

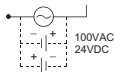

⚠ WARNING

- Do not touch terminals while the power is supplied.

⚠ WARNING

- Do not touch terminals while the power is supplied.

(3)	Model	Rated Load Voltage
	A1SY14EU	24 VDC, 100 to 240 VDC

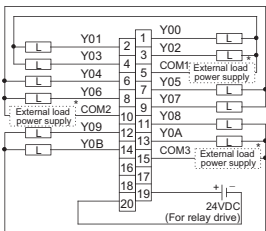

*: The external load power supply section is as shown below.

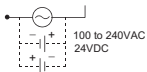

WARNING

● Do not touch terminals while the power is supplied.

(4)	Model	Rated Load Voltage
	A1SY18A A1SY18AEU	24 VDC, 100 to 240 VDC

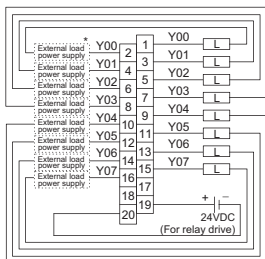

*: The external load power supply section is as shown below.

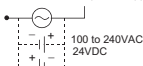

WARNING

● Do not touch terminals while the power is supplied.

(5)	Model	Rated Load Voltage
	A1SY22	100 to 200 VAC

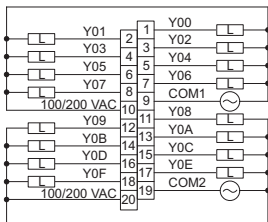

WARNING

● Do not touch terminals while the power is supplied.

(6)	Model	Rated Load Voltage
	A1SY28A	100 to 200 VAC

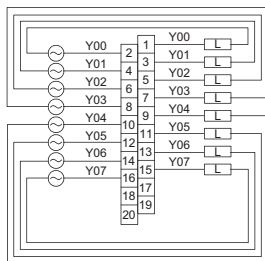

WARNING

● Do not touch terminals while the power is supplied.

(7)	Model	Rated Load Voltage
	A1SY28EU	100 to 240 VAC

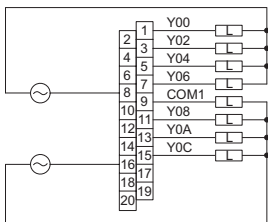

WARNING

● Do not touch terminals while the power is supplied.

(8)	Model	Rated Load Voltage
	A1SY40 A1SY40P	12/24 VAC

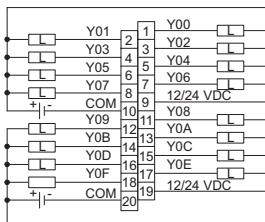

(9)	Model	Rated Load Voltage
	A1SY50	12/24 VDC
	A1SY60	24 VDC

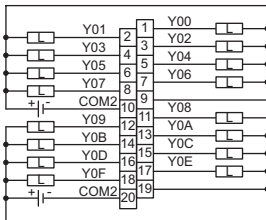

(10)	Model	Rated Load Voltage
	A1SY60E	5/12/24 VDC

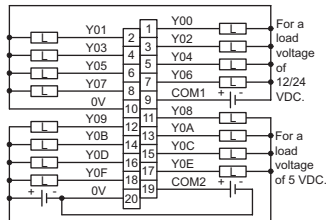

* When using a working load voltage of 5VDC, a separate 12/24VDC source is required for the external power supply.

(11)	Model	Rated Load Voltage
	A1SY68A	5/12/24/48 VDC

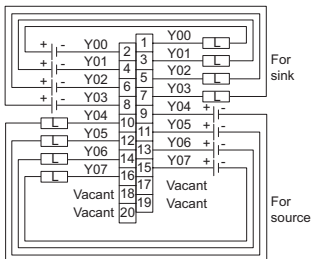

(12)	Model	Rated Load Voltage
	A1SY80	12/24 VAC

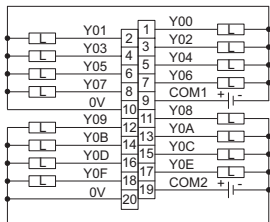

	Model	Rated Load Voltage
(13)	A1SY41	12/24 VDC
	A1SY41P	

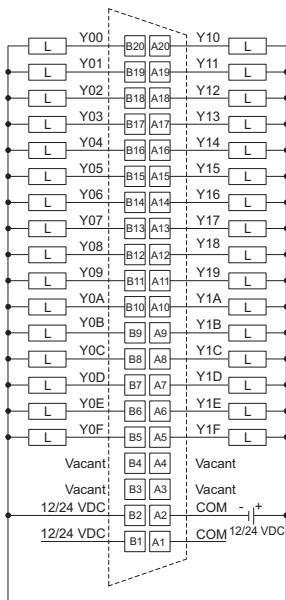

*1 **B1** and **B2**, and **A1** and **A2**, are connected internally.

*2 The A and B pin number rows shown above are transposed with respect to the diagram of the A and B rows which is printed on the module. Remember that the A row pin numbers correspond to the B row of the module.

	Model	Rated Load Voltage
(14)	A1SY42	12/24 VDC
	A1SY42P	

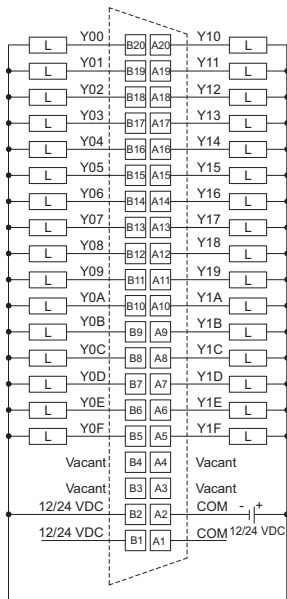

*1 The figure above indicates **F** (the first half 32 points). The connections for **L** (the latter half 32 points) are the same as for **F** (regard Y00 to Y1F as Y20 to Y3F.) **B1** and **B2**, and **A1** and **A2**, are connected internally.

*2 The A and B pin number rows shown above are transposed with respect to the diagram of the A and B rows which is printed on the module. Remember that the A row pin numbers correspond to the B row of the module.

	Model	Rated Load Voltage
(15)	A1SY71	5/12 VDC

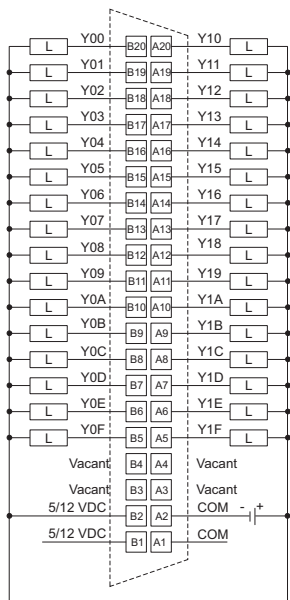

*1 [B1] and [B2], and [A1] and [A2], are connected internally.

*2 The A and B pin number rows shown above are transposed with respect to the diagram of the A and B rows which is printed on the module. Remember that the A row pin numbers correspond to the B row of the module.

	Model	Rated Load Voltage
(16)	A1SY81	12/24 VDC
	A1SY81EP	

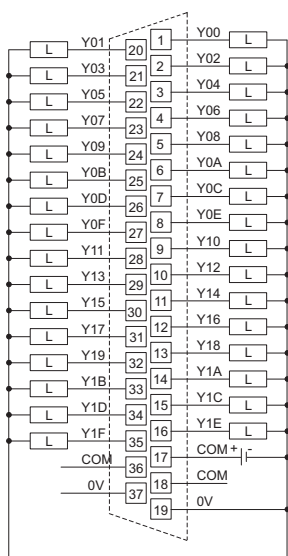

● [17] and [18] and [36], and [19] and [37] are connected internally.

(17)	Model	Rated Load Voltage
	A1SY82	12/24 VDC

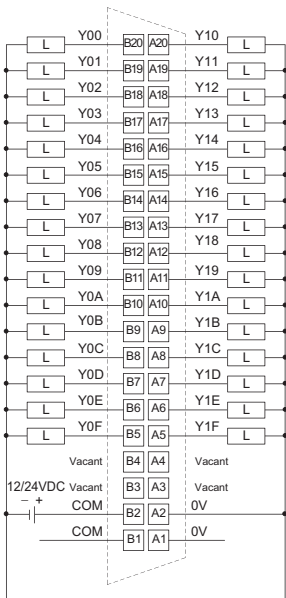

- *1 The figure above indicates **F** (the first half 32 points).
 The connections for **L** (the latter half 32 points) are the same as for **F** (regard Y00 to Y1F as Y20 to Y3F.)
B1 and **B2**, and **A1** and **A2**, are connected internally.
- *2 The A and B pin number rows shown above are transposed with respect to the diagram of the A and B rows which is printed on the module. Remember that the A row pin numbers correspond to the B row of the module.

(18)	Model	Rated Load Voltage
	A1S42Y	12/24 VDC

Pin Arrangement

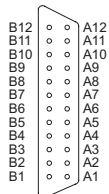

Seen from front face of the module

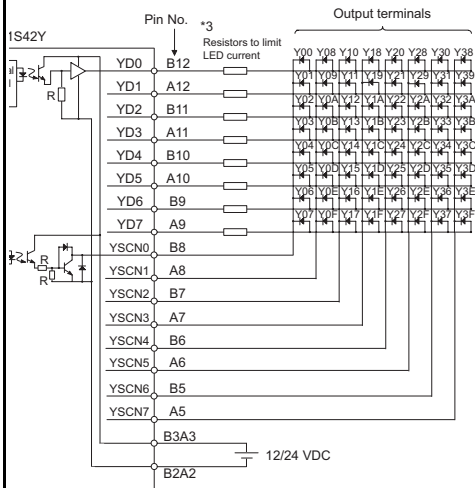

Pin No.	Signal Name (F _H)	Pin No.	Signal Name (F _H)
B12	YD0	A12	YD1
B11	YD2	A11	YD3
B10	YD4	A10	YD5
B9	YD6	A9	YD7
B8	YSCN 0	A8	YSCN 1
B7	YSCN 2	A7	YSCN 3
B6	YSCN 4	A6	YSCN 5
B5	YSCN 6	A5	YSCN 7
B4	Vacant	A4	Vacant
B3	12/24 VDC	A3	12/24 VDC
B2	0V	A2	0V
B1	Vacant	A1	Vacant

- *1 The fuse in the output module is provided to prevent the external wiring from burning in the event of a short circuit in the module's output. Consequently, it may not be able to protect output devices. If an output device is damaged in a failure mode other than a short circuit, the fuse might not be blown.
- *2 The "ERR." LED will also come ON when the external power supply is cut.

- *3 Mount the resistors to limit LED current externally to the A1S42Y.



- *4 The power supply voltage (12/24VDC) is applied in the LED's reverse direction. If the peak inverse voltage is insufficient, connect protective diodes in series with each of the LEDs.

5.3 Input/output combined modules

5.3.1 Input/output combined module specifications

Model	Type	No. of Points	Rated Input Voltage	Input Current	Operating Voltage	
					ON Voltage	OFF Voltage
A1SH42	DC Input (sink type)	32	12/24VDC	2/5mA	8VDC or higher	4VDC or lower
A1SH42P						
A1SH42-S1			24VDC	5mA	15VDC or higher	3VDC or lower
A1SH42P-S1						
A1SX48Y18		8	24VDC	7mA	14VDC or higher	6.5VDC or lower
A1SX48Y58						

Model	Type	No. of Points	Rated Load Voltage	Max. Load Current		Max. Output Response Time	
				1 Point	Common	OFF to ON	ON to OFF
A1SH42	Transistor Output (sink type)	32	12/ 24VDC	0.1A	1.6A	2ms or lower	2ms or lower
A1SH42P					2A	1ms or lower	1ms or lower
A1SH42-S1					1.6A	2ms or lower	2ms or lower
A1SH42P-S1					2A	1ms or lower	1ms or lower
A1SX48Y18	Relay Output	8	24VDC 240VAC	2A	8A	10ms or lower	12ms or lower
A1SX48Y58	Transistor Output (sink type)		12/ 24VDC	0.5A	2A	2ms or lower	2ms or lower

For all modules, the insulation system is photocoupler insulation and the operation status is provided by LED indications.

	Max. Simultaneous Input Points (Percentage Simultaneously ON)	Max. Response Time		No. of Occupied Points
		OFF to ON	ON to OFF	
	60%(24VDC)	10ms or lower	10ms or lower	32
		0.3ms or lower	0.3ms or lower	
	100%(26.4VDC)	10ms or lower	10ms or lower	8

	Points/ Common	Field Wiring	Surge Suppression	Fuse Rating	External Power Supply (TYP 24VDC)	External Current Consumption (5VDC)	No. of Occupied Points
					Current		
	32	40-pin Connector	Zener diode	3.2A	0.008A	0.5A	32
				None	0.012A	0.13A	
				3.2A	0.008A	0.5A	
				None	0.012A	0.13A	
	8	Terminal	None	None	0.045A	0.085A	16
			Zener diode	3.2A	0.06A	0.06A	

5.3.2 Input/output composite module connections

	Model	Rated Input Voltage	Rated Load Voltage
(1)	A1SH42	12/24 VDC	12/24 VDC
	A1SH42P		
	A1SH42-S1	24 VDC	
	A1SH42P-S1		

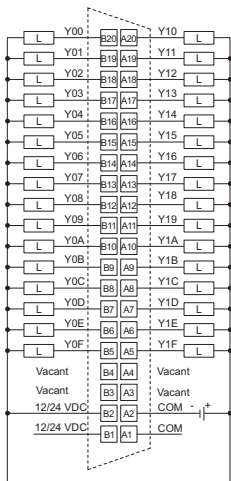
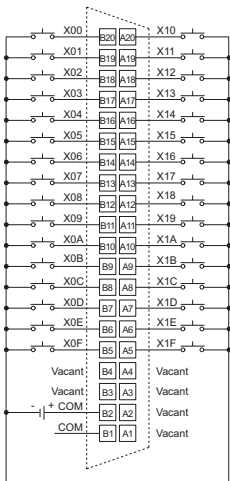

X(Input side)

Y(Output side)

*1 **B1** and **B2** are connected internally.

*3 **B1** and **B2**, and **A1** and **A2**, are connected internally.

*2 The A and B pin number rows shown above are transposed with respect to the diagram of the A and B rows which is printed on the module. Remember that the A row pin numbers correspond to the B row of the module.

(2)	Model	Rated Input Voltage	Rated Load Voltage
	A1SX48Y18	24 VDC	24 VDC/ 240 VAC

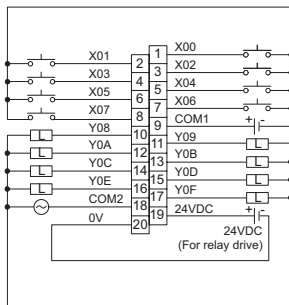

WARNING ● Do not touch terminal while the power is supplied.

(3)	Model	Rated Input Voltage	Rated Load Voltage
	A1SX48Y58	24 VDC	12/24 VDC

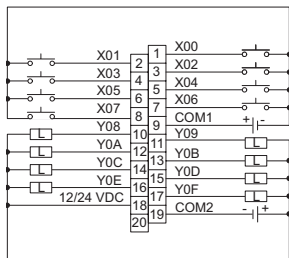

6. ERROR CODE

If an error occurs when the programmable controller is powered ON, switched to RUN status or running, the Q2ASCPU module executes the self diagnostics function to display the error (LED display, message display) and store the error information into the special relay SM and special register SD.

Also, if an error occurs when a communication request is issued from a peripheral device, special function module or network system, the Q2ASCPU module returns the error code (4000_H to 4FFF_H) to the request source.

The following explains the Q2ASCPU errors and the corresponding corrective actions.

Remarks

The error code of the error that occurred when a general data processing request is made from the peripheral device, special function module or network system is not stored into SD0 of the Q2ASCPU. The error code is returned to the source of the general data processing request.

6.1 Error Code Type

Errors are detected by the self diagnostics function of CPU module or during communication with CPU module.

The following table classifies the errors according to the detection pattern, detection location and error code.

Error detection pattern	Error detection location	Error code	Reference
Detection by the self diagnostics function of CPU module	CPU module	1000 to 10000*1	Section 6.3
Detection at communication with CPU module	CPU module	4000 _H to 4FFF _H	Q2A(S1)/Q3A/Q4ACPU User's Manual
	Serial communication module, etc.	7000 _H to 7FFF _H	Serial Communication User's Manual, etc.
	CC-Link module	B000 _H to BFFF _H	CC-Link System Master/Local Module User's Manual
	Ethernet module	C000 _H to CFFF _H	Ethernet Interface Module User's Manual
	MELSECNET/H, MELSECNET/10 network module	F000 _H to FFFF _H	For QnA/Q4AR MELSECNET/10 Network System Reference Manual

*1: CPU module error codes are classified into minor, moderate, major errors as shown below.

- **Minor error:** Errors that may allow the CPU module to continue the operation, e.g., battery error.
(Error code: 1300 to 10000)
- **Moderate error:** Errors that may cause the CPU module to stop the operation, e.g., WDT error.
(Error code: 1300 to 10000)
- **Major error:** Errors that may cause the CPU module to stop the operation, e.g., RAM error.
(Error code: 1000 to 1299)

Determine the error level, i.e. whether the operation can be continued or stopped, by referring to "Operating Statuses of CPU" described in Section 6.3 "Error Code List".

6.2 Reading Error Code

When an error occurs, the corresponding error code and error message can be read out using a peripheral device.

For details on peripheral device operation, refer to GX Developer Operating Manual or SW□IVD-GPPQ/SW□NX-GPPQ Operating Manual (Online).

6.3 Error Code List

The following information deals with error codes and the meanings, causes, and corrective measures of error messages.

<Relevant CPU>

QnA: Indicates the QnA series and Q2ASCPU series.

Each CPU module model name: Indicates the relevant specific CPU module. (Example: Q4AR, Q2AS)

Error Code	Error Contents and Cause	Corrective Action	LED Status CPU Status	Corre- sponding CPU
1000	<p>[MAIN CPU DOWN] Runaway or failure of CPU module or failure of main CPU</p> <ul style="list-style-type: none"> • Malfunctioning due to noise or other reason • Hardware fault <p>■Collateral informationmmon</p> <ul style="list-style-type: none"> • Common Information:– • Individual Information:– <p>■Diagnostic Timing</p> <ul style="list-style-type: none"> • Always 	<ul style="list-style-type: none"> • Take noise reduction measures. • Reset the CPU module and RUN it again.If the same error is displayed again, this suggests a CPU module hardware fault.(Contact your local Mitsubishi representative.) 		
1010	<p>[END NOT EXECUTE] Entire program was executed without the execution of an END instruction.</p> <ul style="list-style-type: none"> • When the END instruction is executed it is read as another instruction code, e.g. due to noise. • The END instruction has been changed to another instruction code somehow. <p>■Collateral informationmmon</p> <ul style="list-style-type: none"> • Common Information:– • Individual Information:– <p>■Diagnostic Timing</p> <ul style="list-style-type: none"> • When an END instruction executed 	<ul style="list-style-type: none"> • Take noise reduction measures. • Reset the CPU module and RUN it again. If the same error is displayed again, this suggests a CPU module hardware fault. (Contact your local Mitsubishi representative.) 	<p>RUN: Off ERR.: Flicker</p> <p>CPU Status: Stop</p>	QnA
1101	<p>[RAM ERROR] The sequence program storing built-in RAM/program memory in the CPU module is faulty.</p> <p>■Collateral informationmmon</p> <ul style="list-style-type: none"> • Common Information:– • Individual Information:– <p>■Diagnostic Timing</p> <ul style="list-style-type: none"> • At power ON/ At reset/ When an END instruction executed 	<ul style="list-style-type: none"> • Take noise reduction measures. • Reset the CPU module and RUN it again. If the same error is displayed again, this suggests a CPU module hardware fault.(Contact your local Mitsubishi representative.) 		

Error Code	Error Contents and Cause	Corrective Action	LED Status CPU Status	Corre- sponding CPU
1102	<p>[RAM ERROR]</p> <ul style="list-style-type: none"> • The work area RAM in the CPU module is faulty. • The standard RAM and extended RAM in the CPU module are faulty. <p>■Collateral information</p> <ul style="list-style-type: none"> • Common Information:– • Individual Information:– <p>■Diagnostic Timing</p> <ul style="list-style-type: none"> • At power ON/ At reset/ When an END instruction executed 	<ul style="list-style-type: none"> • Take noise reduction measures. • Reset the CPU module and RUN it again. If the same error is displayed again, this suggests a CPU module hardware fault. (Contact your local Mitsubishi representative.) 	RUN: Off ERR.: Flicker CPU Status: Stop	QnA
1103	<p>[RAM ERROR]</p> <p>The device memory in the CPU module is faulty.</p> <p>■Collateral information</p> <ul style="list-style-type: none"> • Common Information:– • Individual Information:– <p>■Diagnostic Timing</p> <ul style="list-style-type: none"> • At power ON/At reset 	<ul style="list-style-type: none"> • Take noise reduction measures. • When indexing is performed, check the value of index register to see if it is within the device range. • Reset the CPU module and RUN it again. If the same error is displayed again, this suggests a CPU module hardware fault. (Contact your local Mitsubishi representative.) 		
1104	<p>[RAM ERROR]</p> <p>The address RAM in the CPU module is faulty.</p> <p>■Collateral information</p> <ul style="list-style-type: none"> • Common Information:– • Individual Information:– <p>■Diagnostic Timing</p> <ul style="list-style-type: none"> • At power ON/At reset 	<ul style="list-style-type: none"> • Take noise reduction measures. • Reset the CPU module and RUN it again. If the same error is displayed again, this suggests a CPU module hardware fault. (Contact your local Mitsubishi representative.) 		
1105	<p>[RAM ERROR]</p> <p>The system RAM in the CPU module is faulty.</p> <p>■Collateral information</p> <ul style="list-style-type: none"> • Common Information:– • Individual Information:– <p>■Diagnostic Timing</p> <ul style="list-style-type: none"> • At power ON/At reset 	<ul style="list-style-type: none"> • Take noise reduction measures. • Reset the CPU module and RUN it again. If the same error is displayed again, this suggests a CPU module hardware fault. (Contact your local Mitsubishi representative.) 		Q4AR

Error Code	Error Contents and Cause	Corrective Action	LED Status CPU Status	Corre- sponding CPU
1200	<p>[OPE. CIRCUIT ERR.] The operation circuit for index modification in the CPU module does not operate normally.</p> <p>■Collateral information • Common Information:– • Individual Information:–</p> <p>■Diagnostic Timing • At power ON/At reset</p>	This suggests a CPU module hardware fault. (Contact your local Mitsubishi representative.)	RUN: Off ERR.: Flicker CPU Status: Stop	QnA
1201	<p>[OPE. CIRCUIT ERR.] The hardware (logic) in the CPU module does not operate normally.</p> <p>■Collateral information • Common Information:– • Individual Information:–</p> <p>■Diagnostic Timing • At power ON/At reset</p>			
1202	<p>[OPE. CIRCUIT ERR.] The operation circuit for sequence processing in the CPU module does not operate normally.</p> <p>■Collateral information • Common Information:– • Individual Information:–</p> <p>■Diagnostic Timing • At power ON/At reset</p>			
1203	<p>[OPE. CIRCUIT ERR.] The operation circuit for index modification in the CPU module does not operate normally.</p> <p>■Collateral information • Common Information:– • Individual Information:–</p> <p>■Diagnostic Timing • When an END instruction executed</p>			Q4AR
1204	<p>[OPE. CIRCUIT ERR.] The hardware (logic) in the CPU module does not operate normally.</p> <p>■Collateral information • Common Information:– • Individual Information:–</p> <p>■Diagnostic Timing • When an END instruction executed</p>			

Error Code	Error Contents and Cause	Corrective Action	LED Status CPU Status	Corresponding CPU
1205	<p>[OPE. CIRCUIT ERR.] The operation circuit for sequence processing in the CPU module does not operate normally.</p> <p>■Collateral informationmmon</p> <ul style="list-style-type: none"> • Common Information:– • Individual Information:– <p>■Diagnostic Timing</p> <ul style="list-style-type: none"> • When an END instruction executed 	This suggests a CPU module hardware fault. (Contact your local Mitsubishi representative.)	RUN: Off ERR.: Flicker	QnA
1206	<p>[OPE. CIRCUIT ERR.] The DSP operation circuit in the CPU module does not operate normally.</p> <p>■Collateral informationmmon</p> <ul style="list-style-type: none"> • Common Information:– • Individual Information:– <p>■Diagnostic Timing</p> <ul style="list-style-type: none"> • When instruction executed 		CPU Status: Stop	Q4AR

Error Code	Error Contents and Cause	Corrective Action	LED Status CPU Status	Corresponding CPU
1300	<p>[FUSE BREAK OFF] There is an output module with a blown fuse.</p> <p>■Collateral informationmmon</p> <ul style="list-style-type: none"> • Common Information:Module No.(Slot No.) [For Remote I/O network] Network No./Station No. • Individual Information:– <p>■Diagnostic Timing</p> <ul style="list-style-type: none"> • Always 	<ul style="list-style-type: none"> • Check ERR. LED of the output modules and replace the fuse of the module whose LED is lit. • Read the common information of the error using the peripheral device and replace the fuse at the output module corresponding to the numerical value (module No.) reading. Alternatively, monitor special registers SD1300 to SD1331 with the peripheral device and change the fuse of the output module whose bit has a value of "1". • When a GOT is bus-connected to the main base unit or extension base unit, check the connection status of the extension cable and the grounding status of the GOT. 	RUN: Off/On ERR.: Flicker/ On	QnA Q4AR
	<p>[FUSE BREAK OFF]</p> <ul style="list-style-type: none"> • There is an output module with a blown fuse. • External power supply for output load is turned off or disconnected. <p>■Collateral informationmmon</p> <ul style="list-style-type: none"> • Common Information:Module No.(Slot No.) [For Remote I/O network] Network No./Station No. • Individual Information:– <p>■Diagnostic Timing</p> <ul style="list-style-type: none"> • Always 	<ul style="list-style-type: none"> • Check ERR. LED of the output modules and replace the module whose LED is lit. • Read the common information of the error using the peripheral device and replace the fuse at the output module corresponding to the numerical value (module No.) reading. Alternatively, monitor special registers SD1300 to SD1331 with the peripheral device and change the fuse of the output module whose bit has a value of "1". • Check whether the external power supply for output load is ON or OFF. • When a GOT is bus-connected to the main base unit or extension base unit, check the connection status of the extension cable and the earth status of the GOT. 	CPU Status: Stop/ Continue *1	Q2AS

*1 CPU operation can be set in the parameters at error occurrence. (LED indication varies.)

Error Code	Error Contents and Cause	Corrective Action	LED Status CPU Status	Corre- sponding CPU
1310	<p>[I/O INT. ERROR] An interruption has occurred although there is no interrupt module.</p> <p>■Collateral information <ul style="list-style-type: none"> • Common Information:— • Individual Information:— </p> <p>■Diagnostic Timing <ul style="list-style-type: none"> • During interrupt </p>	Any of the mounted modules is experiencing a hardware fault. Therefore, check the mounted modules and change the faulty module. (Contact your local Mitsubishi representative.)	<p>RUN: Off ERR.: Flicker</p> <p>CPU Status: Stop</p>	QnA
1401	<p>[SP. UNIT DOWN] When PLC parameter I/O allocation was being made, there was no return signal from the special function module during initial processing stage.(When error is generated, the head I/O number of the special function module that corresponds to the common information is stored.)</p> <p>■Collateral information <ul style="list-style-type: none"> • Common Information:Module No.(Slot No.) • Individual Information:— </p> <p>■Diagnostic Timing <ul style="list-style-type: none"> • At power ON/At reset </p>	The CPU module, base unit and/or the special function module that was accessed is experiencing a hardware fault. (Contact your local Mitsubishi representative.)	<p>RUN: Off ERR.: Flicker</p> <p>CPU Status: Stop*2</p>	
1402	<p>[SP. UNIT DOWN] The special function module was accessed during the execution of a FROM/TO instruction set, but there was no response. (When an error is generated, the program error location corresponding to the individual information is stored.)</p> <p>■Collateral information <ul style="list-style-type: none"> • Common Information:Module No.(Slot No.) • Individual Information:Program error location </p> <p>■Diagnostic Timing <ul style="list-style-type: none"> • During execution of FROM/TO instruction set </p>	The CPU module, base unit and/or the special function module that was accessed is experiencing a hardware fault.(Contact your local Mitsubishi representative.)	<p>RUN: Off ERR.: Flicker</p> <p>CPU Status: Stop</p>	

*2 The BAT.AL.M LED turns on at BATTERY ERROR.

Error Code	Error Contents and Cause	Corrective Action	LED Status CPU Status	Corre- sponding CPU
1411	<p>[CONTROL-BUS. ERR.] When performing a parameter I/O allocation the intelligent function module/special function module could not be accessed during initial communications. (On error occurring, the head I/O number of the corresponding intelligent function module/special function module is stored in the common information.)</p> <p>■Collateral informationmmon</p> <ul style="list-style-type: none"> • Common Information:Module No.(Slot No.) • Individual Information:– <p>■Diagnostic Timing</p> <ul style="list-style-type: none"> • At power ON / At reset 	Reset the CPU module and RUN it again. If the same error is displayed again, the intelligent function module/special function module, CPU module or base unit is faulty. (Contact your local Mitsubishi representative.)	RUN: Off ERR.: Flicker CPU Status: Stop	QnA
1412	<p>[CONTROL-BUS. ERR.] The FROM/TO instruction is not executable, due to a control bus error with the intelligent function module/special function module. (On error occurring, the program error location is stored in the individual information.)</p> <p>■Collateral informationmmon</p> <ul style="list-style-type: none"> • Common Information:Module No.(Slot No.) • Individual Information:Program error location <p>■Diagnostic Timing</p> <ul style="list-style-type: none"> • During execution of FROM/TO instruction set 			
1421	<p>[SYS. UNIT DOWN] Hardware fault at the system management module AS92R.</p> <p>■Collateral informationmmon</p> <ul style="list-style-type: none"> • Common Information:– • Individual Information:– <p>■Diagnostic Timing</p> <ul style="list-style-type: none"> • Always 	This suggests a system management module AS92R hardware fault. (Contact your local Mitsubishi representative.)		Q4AR

Error Code	Error Contents and Cause	Corrective Action	LED Status CPU Status	Corre- sponding CPU
1500	<p>[AC/DC DOWN]</p> <ul style="list-style-type: none"> • A momentary power supply interruption has occurred. • The power supply went off. <p>■Collateral informationmmon</p> <ul style="list-style-type: none"> • Common Information:– • Individual Information:– <p>■Diagnostic Timing</p> <ul style="list-style-type: none"> • Always 	Check the power supply.	RUN: On ERR.: Off CPU Status: Continue	QnA
1510	<p>[DUAL DC DOWN 5V]</p> <p>The power supply voltage (100 to 240VAC) of either of the two power supply modules on the power supply duplexing extension base unit dropped to or below 85% of the rated voltage. (This can be detected from the control system of the redundant system.)</p> <p>■Collateral informationmmon</p> <ul style="list-style-type: none"> • Common Information:– • Individual Information:– <p>■Diagnostic Timing</p> <ul style="list-style-type: none"> • Always 	Check the supply voltage of the power supply module. If the voltage is abnormal then replace the power supply module.	RUN: On ERR.: On CPU Status: Continue	Q4AR
1520	<p>[DC DOWN 5V]</p> <p>The voltage(100 to 240VAC) of the power supply module on the extension base unit dropped to or below 85% of the rated voltage. (This can be detected from the control system of the stand-alone system or redundant system.)</p> <p>■Collateral informationmmon</p> <ul style="list-style-type: none"> • Common Information:– • Individual Information:– <p>■Diagnostic Timing</p> <ul style="list-style-type: none"> • Always 	Check the supply voltage of the power supply module. If the voltage is abnormal then replace the power supply module.	RUN: Off ERR.: Flicker CPU Status: Stop	

Error Code	Error Contents and Cause	Corrective Action	LED Status CPU Status	Corre- sponding CPU
1530	<p>[DC DOWN 24V] The 24 VDC power supplied to the system management module AS92R has dropped below 90% of the rated voltage. (This can be detected from the control system or standby system of the redundant system.)</p> <p>■Collateral information <ul style="list-style-type: none"> • Common Information:– • Individual Information:– </p> <p>■Diagnostic Timing <ul style="list-style-type: none"> • Always </p>	Check the 24VDC power supplied to the system management module AS92R.	RUN: On ERR.: On CPU Status: Continue	Q4AR
1600	<p>[BATTERY ERROR*²] <ul style="list-style-type: none"> • The battery voltage in the CPU module has dropped below stipulated level. • The lead connector of the CPU module battery is not connected. </p> <p>■Collateral information <ul style="list-style-type: none"> • Common Information:Drive Name • Individual Information:– </p> <p>■Diagnostic Timing <ul style="list-style-type: none"> • Always </p>	<ul style="list-style-type: none"> • Change the battery. • If the battery is for program memory, standard RAM or for the back-up power function, install a lead connector. 	RUN: On ERR.: Off CPU Status: Continue	QnA
1601	<p>[BATTERY ERROR*²] Voltage of the battery on memory card 1 has dropped below stipulated level.</p> <p>■Collateral information <ul style="list-style-type: none"> • Common Information:Drive Name • Individual Information:– </p> <p>■Diagnostic Timing <ul style="list-style-type: none"> • Always </p>	Change the battery.	CPU Status: Continue	
1602	<p>[BATTERY ERROR*²] Voltage of the battery on memory card 2 has dropped below stipulated level.</p> <p>■Collateral information <ul style="list-style-type: none"> • Common Information:Drive Name • Individual Information:– </p> <p>■Diagnostic Timing <ul style="list-style-type: none"> • Always </p>	Change the battery.	RUN: On ERR.: On CPU Status: Continue	

*2 The BAT.ALM LED turns on at BATTERY ERROR.

Error Code	Error Contents and Cause	Corrective Action	LED Status CPU Status	Corre- sponding CPU
2000	<p>[UNIT VERIFY ERR.] I/O module information power ON is changed.</p> <ul style="list-style-type: none"> I/O module (or special function module) not installed properly or installed on the base unit. <p>■Collateral informationmmon</p> <ul style="list-style-type: none"> Common Information:Module No.(Slot No.) [For Remote I/O network] Network No./Station No. Individual Information:– <p>■Diagnostic Timing</p> <ul style="list-style-type: none"> When an END instruction executed 	<ul style="list-style-type: none"> Read the common information of the error using the peripheral device, and check and/or change the module that corresponds to the numerical value (module number) there. Alternatively, monitor the special registers SD1400 to SD1431 at a peripheral device, and change the fuse at the output module whose bit has a value of "1". When a GOT is bus-connected to the main base unit or extension base unit, check the connection status of the extension cable and the grounding status of the GOT. 	<p>RUN: Off/On ERR.: Flicker/ On</p> <p>CPU Status: Stop/ Continue *1</p>	QnA
2100	<p>[SP. UNIT LAY ERR.] In PLC parameter I/O allocation settings, a special function module was allocated to a location reserved for an I/O module. Or, the opposite has happened.</p> <p>■Collateral informationmmon</p> <ul style="list-style-type: none"> Common Information:Module No.(Slot No.) Individual Information:– <p>■Diagnostic Timing</p> <ul style="list-style-type: none"> At power ON/At reset 	<p>Reset the PLC parameter I/O allocation setting to conform with the actual status of the special function modules.</p>	<p>RUN: Off ERR.: Flicker</p>	
2101	<p>[SP. UNIT LAY ERR.] 13 or more special function modules (not counting the A1Si61) capable of sending an interrupt to the CPU module have been installed.</p> <p>■Collateral informationmmon</p> <ul style="list-style-type: none"> Common Information:Module No.(Slot No.) Individual Information:– <p>■Diagnostic Timing</p> <ul style="list-style-type: none"> At power ON/At reset 	<p>Keep the number of special function modules that can initiate an interrupt (with the exception of the A(1S)I61 module) to 12 or fewer.</p>	<p>CPU Status: Stop</p>	

*1 CPU operation can be set in the parameters at error occurrence. (LED indication varies.)

Error Code	Error Contents and Cause	Corrective Action	LED Status CPU Status	Corre- sponding CPU
2102	<p>[SP. UNIT LAY ERR.] Seven or more serial communication modules (excludes A (1S) J71QC24) have been installed.</p> <p>■Collateral information <ul style="list-style-type: none"> • Common Information:Module No.(Slot No.) • Individual Information:-- </p> <p>■Diagnostic Timing <ul style="list-style-type: none"> • At power ON/At reset </p>	Keep the number of serial communication modules (excludes A(1S)J71QU24) installed to six or fewer.	RUN: Off ERR.: Flicker CPU Status: Stop	QnA
2103	<p>[SP. UNIT LAY ERR.] Two or more A (1S) I61 interrupt modules have been mounted.</p> <p>■Collateral information <ul style="list-style-type: none"> • Common Information:Module No.(Slot No.) • Individual Information:-- </p> <p>■Diagnostic Timing <ul style="list-style-type: none"> • At power ON/At reset </p>	Install only 1 A (1S) I61 module.		
2104	<p>[SP. UNIT LAY ERR.] At the MELSECNET/MINI auto refresh network parameter settings, the module allocation that was set is different from the actual module models at the station numbers in the link system.</p> <p>■Collateral information <ul style="list-style-type: none"> • Common Information:Module No.(Slot No.) • Individual Information:-- </p> <p>■Diagnostic Timing <ul style="list-style-type: none"> • At power ON/At reset </p>	Reset the network parameter MELSECNET/MINI auto refresh unit module allocation setting so that it conforms to the station number of the module that is actually linked.		

*1 CPU operation can be set in the parameters at error occurrence. (LED indication varies.)

Error Code	Error Contents and Cause	Corrective Action	LED Status CPU Status	Corresponding CPU																		
2105	<p>[SP. UNIT LAY ERR.] There are too many special function modules that can use dedicated instructions allocated (number of modules installed). (The total of the figures indicated below is above 1344.)</p> <table border="0"> <tr> <td>(AD59</td> <td>modules installed x 5)</td> </tr> <tr> <td>(AD57(S1)/AD58</td> <td>modules installed x 8)</td> </tr> <tr> <td>(AJ71C24(S3/S6/S8)</td> <td>modules installed x 10)</td> </tr> <tr> <td>(AJ71UC24</td> <td>modules installed x 10)</td> </tr> <tr> <td>(AJ71C21(S1)</td> <td>modules installed x 29)</td> </tr> <tr> <td>(AJ71PT32-S3/AJ71T32-S3</td> <td>modules installed x 125)</td> </tr> <tr> <td>(AJ71QC24(R2,R4)</td> <td>modules installed x 29)</td> </tr> <tr> <td>(AJ71ID1(2)-R4</td> <td>modules installed x 8)</td> </tr> <tr> <td>(+AD75</td> <td>modules installed x 12)</td> </tr> </table> <p style="text-align: center;">total > 1344</p> <p>*: When the expansion mode is used.</p> <p>■Collateral informationmmon</p> <ul style="list-style-type: none"> • Common Information:Module No.(Slot No.) • Individual Information:– <p>■Diagnostic Timing</p> <ul style="list-style-type: none"> • At power ON/At reset 	(AD59	modules installed x 5)	(AD57(S1)/AD58	modules installed x 8)	(AJ71C24(S3/S6/S8)	modules installed x 10)	(AJ71UC24	modules installed x 10)	(AJ71C21(S1)	modules installed x 29)	(AJ71PT32-S3/AJ71T32-S3	modules installed x 125)	(AJ71QC24(R2,R4)	modules installed x 29)	(AJ71ID1(2)-R4	modules installed x 8)	(+AD75	modules installed x 12)	Reduce the number of special function modules installed.		
(AD59	modules installed x 5)																					
(AD57(S1)/AD58	modules installed x 8)																					
(AJ71C24(S3/S6/S8)	modules installed x 10)																					
(AJ71UC24	modules installed x 10)																					
(AJ71C21(S1)	modules installed x 29)																					
(AJ71PT32-S3/AJ71T32-S3	modules installed x 125)																					
(AJ71QC24(R2,R4)	modules installed x 29)																					
(AJ71ID1(2)-R4	modules installed x 8)																					
(+AD75	modules installed x 12)																					
2106	<p>[SP.UNIT LAY ERR.]</p> <ul style="list-style-type: none"> • Five or more AJ71QLP21 & AJ71QBR11 modules are installed. • Three or more AJ71AP21/ R21 & AJ71AT21B modules are installed. • The total number of installed AJ71QLP21, AJ71QBR11, AJ71AP21/R21, and AJ71AT21B modules exceeds five. • The same network numbers or identical station numbers exist in the MELSECNET/10 network system. • Two or more master or load stations exist simultaneously at the MELSECNET(II) or MELSECNET/B data link system. <p>■Collateral informationmmon</p> <ul style="list-style-type: none"> • Common Information:Module No. (Slot No.) • Individual Information:– <p>■Diagnostic Timing</p> <ul style="list-style-type: none"> • At power ON/At reset 	<ul style="list-style-type: none"> • Reduce the AJ71QLP21 and AJ71QBR11 modules to four or less. • Reduce the AJ71AP21/R21 and AJ71AT21B modules to two or less. • Reduce the AJ71QLP21, AJ71QBR11, AJ71AP21/R21 and AJ71AT21B modules to a total of four or less. • Check the network Nos. and station Nos. • Check the station Nos. 	<p>RUN: Off ERR.: Flicker</p> <p>CPU Status: Stop</p>	QnA																		

Error Code	Error Contents and Cause	Corrective Action	LED Status CPU Status	Corre- sponding CPU
2107	<p>[SP. UNIT LAY ERR.] The start X/Y set in the PLC parameter's I/O assignment settings is overlapped with the one for another module.</p> <p>■Collateral informationmmon</p> <ul style="list-style-type: none"> • Common Information:Module No.(Slot No.) • Individual Information:-- <p>■Diagnostic Timing</p> <ul style="list-style-type: none"> • At power ON/At reset 	Make the PLC parameter's I/O assignment setting again so it is consistent with the actual status of the special function modules.	RUN: Off ERR.: Flicker	QnA
2108	<p>[SP. UNIT LAY ERR.] A(1S)J71LP21 or A(1S)J71BR11 for use with the AnUCPU network module has been installed.</p> <p>■Collateral informationmmon</p> <ul style="list-style-type: none"> • Common Information:Module No.(Slot No.) • Individual Information:-- <p>■Diagnostic Timing</p> <ul style="list-style-type: none"> • At power ON/At reset 	Replace the network module to A(1S)J71QLP21 or A(1S)J71QBR11.	CPU Status: Stop	
2109	<p>[SP. UNIT LAY ERR.] The control system and standby system module configurations are different when a redundant system is in the backup mode.</p> <p>■Collateral informationmmon</p> <ul style="list-style-type: none"> • Common Information:Module No.(Slot No.) • Individual Information:-- <p>■Diagnostic Timing</p> <ul style="list-style-type: none"> • At power ON/At reset 	Check the module configuration of the standby system.	RUN: Off ERR.: Flicker CPU Status: Stop/ Continue *2	Q4AR

*2 The BAT.ALM LED turns on at BATTERY ERROR.

Error Code	Error Contents and Cause	Corrective Action	LED Status CPU Status	Corresponding CPU
2110	<p>[SP. UNIT ERROR]</p> <ul style="list-style-type: none"> The location designated by the FROM/TO instruction set is not the special function module. The module that does not include buffer memory has been specified by the FROM/TO instruction. The special function module, Network module being accessed is faulty. Station not loaded was specified using the instruction whose target was the CPU share memory. <p>■Collateral information</p> <ul style="list-style-type: none"> Common Information:Module No.(Slot No.) Individual Information:Program error location <p>■Diagnostic Timing</p> <ul style="list-style-type: none"> When instruction executed 	<ul style="list-style-type: none"> Read the individual information of the error using the GX Developer, check the FROM/TO instruction that corresponds to that numerical value (program error location), and correct when necessary. The special function module that was accessed is experiencing a hardware fault. Therefore, change the faulty module. Alternatively, contact your local Mitsubishi representative. 	<p>RUN: Off/On ERR.: Flicker/ On</p> <p>CPU Status: Stop/ Continue *1</p>	QnA
2111	<p>[SP. UNIT ERROR]</p> <ul style="list-style-type: none"> The location designated by a link direct device (J□\□) is not a network module. The I/O module (special function module) was nearly removed, completely removed, or mounted during running. <p>■Collateral information</p> <ul style="list-style-type: none"> Common Information:Module No.(Slot No.) Individual Information:Program error location <p>■Diagnostic Timing</p> <ul style="list-style-type: none"> When instruction executed 			

*1 CPU operation can be set in the parameters at error occurrence. (LED indication varies.)

Error Code	Error Contents and Cause	Corrective Action	LED Status CPU Status	Corresponding CPU
2112	<p>[SP. UNIT ERROR]</p> <ul style="list-style-type: none"> The module other than special function module is specified by the special function module dedicated instruction. Or, it is not the corresponding special function module. The module model specified by the special function module dedicated instruction and that specified by the parameter I/O assignment is different. <p>■Collateral informationmmon</p> <ul style="list-style-type: none"> Common Information:Module No.(Slot No.) Individual Information:Program error location <p>■Diagnostic Timing</p> <ul style="list-style-type: none"> When instruction executed/ STOP → RUN 	<ul style="list-style-type: none"> Read the individual information of the error using a peripheral device, and check the special function module dedicated instruction (network instruction) that corresponds to the value (program error part) to make modification. Set the module model by PLC parameter I/O assignment according to the special function module dedicated instruction setting. Example) Although AJ71QC24N is used actually, AJ71QC24 is set. 	<p>RUN: Off/On ERR.: Flicker/ On</p> <p>CPU Status: Stop/ Continue*1</p>	QnA
2113	<p>[SP. UNIT ERROR]</p> <p>Data of special function module to be simulated is not set in the simulation date.</p> <p>■Collateral informationmmon</p> <ul style="list-style-type: none"> Common Information:FFFFH (fixed) Individual Information:Program error location <p>■Diagnostic Timing</p> <ul style="list-style-type: none"> When instruction executed/ STOP → RUN 	<p>Read the individual information of the error using a peripheral device, and check the special function module /special function module dedicated instruction (network instruction) that corresponds to the value (program error part) to make modification.</p>		

*1 CPU operation can be set in the parameters at error occurrence. (LED indication varies.)

Error Code	Error Contents and Cause	Corrective Action	LED Status CPU Status	Corre- sponding CPU
2210	<p>[BOOT ERROR] There is no boot file in the drive designated by the parameter enabled drive switch even though the Boot DIP switch is ON.</p> <p>■Collateral information <ul style="list-style-type: none"> • Common Information: Drive name • Individual Information:— </p> <p>■Diagnostic Timing <ul style="list-style-type: none"> • At power ON/At reset </p>	<p>Check and correct the valid parameter drive settings made by the DIP switches. Set the boot file to the drive specified by the parameter drive DIP switches.</p>	<p>RUN: Off ERR.: Flicker</p> <p>CPU Status: Stop</p>	
2300	<p>[ICM. OPE. ERROR]</p> <ul style="list-style-type: none"> • A memory card was removed without switching the memory card in/out switch OFF. • The memory card in/out switch is turned ON although a memory card is not actually installed. <p>■Collateral information <ul style="list-style-type: none"> • Common Information: Drive name • Individual Information:— </p> <p>■Diagnostic Timing <ul style="list-style-type: none"> • When memory card is inserted or removed/When memory card is inserted </p>	<ul style="list-style-type: none"> • Remove memory card after placing the memory card in/out switch OFF. • Turn on the card insert switch after inserting a memory card. 	<p>RUN: Off/On ERR.: Flicker/ On</p> <p>CPU Status: Stop/ Continue *1</p>	QnA
2301	<p>[ICM. OPE. ERROR]</p> <ul style="list-style-type: none"> • The memory card has not been formatted. • Memory card format status is incorrect. <p>■Collateral information <ul style="list-style-type: none"> • Common Information: Drive name • Individual Information:— </p> <p>■Diagnostic Timing <ul style="list-style-type: none"> • When memory card is inserted or removed/When memory card is inserted </p>	<ul style="list-style-type: none"> • Format memory card. • Reformat memory card. 	<p>CPU Status: Stop/ Continue *1</p>	

*1 CPU operation can be set in the parameters at error occurrence. (LED indication varies.)

Error Code	Error Contents and Cause	Corrective Action	LED Status CPU Status	Corre- sponding CPU
2302	<p>[ICM. OPE. ERROR] A memory card that cannot be used with the CPU module has been installed.</p> <p>■Collateral informationmmon</p> <ul style="list-style-type: none"> • Common Information:Drive name • Individual Information:– <p>■Diagnostic Timing</p> <ul style="list-style-type: none"> • When memory card is inserted or removed 	<ul style="list-style-type: none"> • Format memory card. • Reformat memory card. • Check memory card. 	<p>RUN: Off/On ERR.: Flicker/ On</p> <p>CPU Status: Stop/ Continue *1</p>	QnA
2400	<p>[FILE SET ERROR] The file designated at the PLC file settings in the parameters cannot be found.</p> <p>■Collateral informationmmon</p> <ul style="list-style-type: none"> • Common Information:File name/Drive name • Individual Information:Parameter number <p>■Diagnostic Timing</p> <ul style="list-style-type: none"> • At power ON/At reset/ At writing to progurammable controller 	<ul style="list-style-type: none"> • Read the individual information of the error using peripheral device, check to be sure that the parameter drive name and file name correspond to the numerical values there (parameter number), and correct. • Create a file created using parameters, and load it to the CPU module. 	<p>RUN: Off ERR.: Flicker</p>	
2401	<p>[FILE SET ERROR] The file specified by parameters cannot be made.</p> <p>■Collateral informationmmon</p> <ul style="list-style-type: none"> • Common Information:File name/Drive name • Individual Information:Parameter number <p>■Diagnostic Timing</p> <ul style="list-style-type: none"> • At power ON/At reset/ At writing to progurammable controller 	<ul style="list-style-type: none"> • Read the individual information of the error using the peripheral device, check to be sure that the parameter drive name and file name correspond to the numerical values there (parameter number), and correct. • Check the space remaining in the memory card. 	<p>CPU Status: Stop</p>	

*1 CPU operation can be set in the parameters at error occurrence. (LED indication varies.)

Error Code	Error Contents and Cause	Corrective Action	LED Status CPU Status	Corresponding CPU
2402	<p>[FILE SET ERROR] Though the file register has been set in the pairing setting/tracking setting, the file register does not exist.</p> <p>■Collateral information <ul style="list-style-type: none"> Common Information:File name/Drive name Individual Information:Parameter number </p> <p>■Diagnostic Timing <ul style="list-style-type: none"> At power ON/At reset/ At writing to progurammable controller </p>	Confirm the file register and parameter.	RUN: Off ERR.: Flicker CPU Status: Stop	Q4AR
2410	<p>[FILE OPE. ERROR]</p> <ul style="list-style-type: none"> The specified program does not exist in the program memory. This error may occur when the ECALL, EFCALL, PSTOP, PSCAN, POFF or PLOW instruction is executed. The specified file does not exist. <p>■Collateral information <ul style="list-style-type: none"> Common Information:File name/Drive name Individual Information:Program error location </p> <p>■Diagnostic Timing <ul style="list-style-type: none"> When instruction executed </p>	<ul style="list-style-type: none"> Read the individual information of the error using the peripheral device, check to be sure that the program corresponds to the numerical values there (program location), and correct. Create a file created using parameters, and load it to the CPU module. In case a specified file does not exist, write the file to a target memory and/or check the file specified with the instruction again. 	RUN: Off/On ERR.: Flicker/ On CPU Status: Stop/ Continue *1	QnA

*1 CPU operation can be set in the parameters at error occurrence. (LED indication varies.)

Error Code	Error Contents and Cause	Corrective Action	LED Status CPU Status	Corre- sponding CPU
2411	<p>[FILE OPE. ERROR]</p> <ul style="list-style-type: none"> The file is the one which cannot be specified by the sequence program (such as comment file). The specified program exists in the program memory, but has not been registered in the program setting of the Parameter dialog box. <p>This error may occur when the ECALL, EFCALL, PSTOP, PSCAN or POFF instruction is executed.</p> <p>■Collateral informationmmon</p> <ul style="list-style-type: none"> Common Information:File name/Drive name Individual Information:Program error location <p>■Diagnostic Timing</p> <ul style="list-style-type: none"> When instruction executed 	Read the individual information of the error using the peripheral device, check to be sure that the program corresponds to the numerical values there (program location), and correct.	RUN: Off/On ERR.: Flicker/ On	QnA
2412	<p>[FILE OPE. ERROR]</p> <p>The SFC program file is one that cannot be designated by the sequence program.</p> <p>■Collateral informationmmon</p> <ul style="list-style-type: none"> Common Information:File name/Drive name Individual Information:Program error location <p>■Diagnostic Timing</p> <ul style="list-style-type: none"> When instruction executed 	Read the individual information of the error using the peripheral device, check to be sure that the program corresponds to the numerical values there (program location), and correct.	CPU Status: Stop/ Continue *1	
2413	<p>[FILE OPE. ERROR]</p> <p>No data has been written to the file designated by the sequence program.</p> <p>■Collateral informationmmon</p> <ul style="list-style-type: none"> Common Information:File name/Drive name Individual Information:Program error location <p>■Diagnostic Timing</p> <ul style="list-style-type: none"> When instruction executed 	Read the individual information of the error using the peripheral device, check to be sure that the program corresponds to the numerical values there (program location), and correct. Check to ensure that the designated file has not been write protected.		

*1 CPU operation can be set in the parameters at error occurrence. (LED indication varies.)

Error Code	Error Contents and Cause	Corrective Action	LED Status CPU Status	Corresponding CPU
2500	<p>[CAN'T EXE. PRG.]</p> <ul style="list-style-type: none"> • There is a program file that uses a device that is out of the range set in the PLC parameter device setting. • After the PLC parameter setting is changed, only the parameter is written into the PLC. <p>■Collateral information</p> <ul style="list-style-type: none"> • Common Information:File name/Drive name • Individual Information:– <p>■Diagnostic Timing</p> <ul style="list-style-type: none"> • At power ON/At reset 	<ul style="list-style-type: none"> • Read the common information of the error using the peripheral device, check to be sure that the parameter device allocation setting and the program file device allocation correspond to the numerical values there (file name), and correct if necessary. • If PLC parameter device setting is changed, batch-write the parameter and program file into the PLC. 	RUN: Off ERR.: Flicker CPU Status: Stop	QnA
2501	<p>[CAN'T EXE. PRG.]</p> <p>There are multiple program files although "none" has been set at the PLC parameter program settings.</p> <p>■Collateral information</p> <ul style="list-style-type: none"> • Common Information:File name/Drive name • Individual Information:– <p>■Diagnostic Timing</p> <ul style="list-style-type: none"> • At power ON/At reset 	Edit the PLC parameter program setting to "yes". Alternatively, delete unneeded programs.		
2502	<p>[CAN'T EXE. PRG.]</p> <p>The program file is incorrect. Alternatively, the file contents are not those of a sequence program.</p> <p>■Collateral information</p> <ul style="list-style-type: none"> • Common Information:File name/Drive name • Individual Information:– <p>■Diagnostic Timing</p> <ul style="list-style-type: none"> • At power ON/At reset 	Check whether the program version is. * * * QPG, and check the file contents to be sure they are for a sequence program.		
2503	<p>[CAN'T EXE. PRG.]</p> <p>There are no program files at all.</p> <p>■Collateral information</p> <ul style="list-style-type: none"> • Common Information:File name/Drive name • Individual Information:– <p>■Diagnostic Timing</p> <ul style="list-style-type: none"> • At power ON/At reset 	<ul style="list-style-type: none"> • Check program configuration. • Check parameters and program configuration. 		

Error Code	Error Contents and Cause	Corrective Action	LED Status CPU Status	Corre- sponding CPU
2504	<p>[CAN'T EXE. PRG.] Two or more SFC normal programs or control programs have been designated.</p> <p>■Collateral informationmmon</p> <ul style="list-style-type: none"> • Common Information:File name/Drive name • Individual Information:– <p>■Diagnostic Timing</p> <ul style="list-style-type: none"> • At power ON/At reset 	<ul style="list-style-type: none"> • Check program configuration. • Check parameters and program configuration. 	<p>RUN: Off ERR.: Flicker</p> <p>CPU Status: Stop</p>	QnA

Error Code	Error Contents and Cause	Corrective Action	LED Status CPU Status	Corresponding CPU
3000	<p>[PARAMETER ERROR] The PLC parameter settings for timer time limit setting, the RUN-PAUSE contact, the common pointer number, general data processing, number of empty slots, system interrupt settings, baud rate setting, and service processing setting are outside the range that can be used by the CPU module.</p> <p>■Collateral informationmmon</p> <ul style="list-style-type: none"> • Common Information:File name/Drive name • Individual Information:Parameter number <p>■Diagnostic Timing</p> <ul style="list-style-type: none"> • At power ON/At reset/STOP → RUN/ At writing to progurammable controller <p>[PARAMETER ERROR] The parameter settings in the error individual information (special register SD16) are illegal.</p> <p>■Collateral informationmmon</p> <ul style="list-style-type: none"> • Common Information:File name/Drive name • Individual Information:Parameter number <p>■Diagnostic Timing</p> <ul style="list-style-type: none"> • At power ON/At reset/STOP → RUN/ At writing to progurammable controller 	<ul style="list-style-type: none"> • Read the individual information of the error using the peripheral device, check the parameter item corresponding to the numerical value (parameter No.), and correct it. • Rewrite corrected parameters to the CPU module, reload the CPU power supply and/or reset the module. • If the same error occurs, it is thought to be a hardware error. (Contact your local Mitsubishi representative.) 	<p>RUN: Off ERR.: Flicker</p> <p>CPU Status: Stop</p>	QnA

Error Code	Error Contents and Cause	Corrective Action	LED Status CPU Status	Corresponding CPU
3001	<p>[PARAMETER ERROR] The parameter settings are corrupted.</p> <p>■Collateral informationmmon</p> <ul style="list-style-type: none"> • Common Information:File name/Drive name • Individual Information:Parameter number <p>■Diagnostic Timing</p> <ul style="list-style-type: none"> • At power ON/At reset/STOP → RUN/ At writing to progurammable controller 	<ul style="list-style-type: none"> • Read the individual information of the error using the peripheral device, check the parameter item corresponding to the numerical value (parameter No.), and correct it. • Rewrite corrected parameters to the CPU module, reload the CPU power supply and/or reset the module. • If the same error occurs, it is thought to be a hardware error. (Contact your local Mitsubishi representative.) 	<p>RUN: Off ERR.: Flicker</p>	QnA
3002	<p>[PARAMETER ERROR] When "Use the following file" is selected for the file register in the PLC file setting of the PLC parameter dialog box, the specified file does not exist although the file register capacity has been set.</p> <p>■Collateral informationmmon</p> <ul style="list-style-type: none"> • Common Information:File name/Drive name • Individual Information:Parameter number <p>■Diagnostic Timing</p> <ul style="list-style-type: none"> • At power ON/At reset/STOP → RUN/ At writing to progurammable controller 	<ul style="list-style-type: none"> • Read the individual information of the error using the peripheral device, check the parameter item corresponding to the numerical value (parameter No.), and correct it. • Rewrite corrected parameters to the CPU module, reload the CPU power supply and/or reset the module. • If the same error occurs, it is thought to be a hardware error. (Contact your local Mitsubishi representative.) 	<p>CPU Status: Stop</p>	

Error Code	Error Contents and Cause	Corrective Action	LED Status CPU Status	Corresponding CPU
3003	<p>[PARAMETER ERROR] ■Collateral information <ul style="list-style-type: none"> • Common Information:File name/Drive name • Individual Information:Parameter number ■Diagnostic Timing <ul style="list-style-type: none"> • When an END instruction executed </p>	<ul style="list-style-type: none"> • Read the individual information of the error using the peripheral device, check the parameter item corresponding to the numerical value (parameter No.), and correct it. • If the error is still generated following the correction of the parameter settings, the possible cause is the memory error of the CPU module's built-in RAM or program memory or the memory card. (Contact your local Mitsubishi representative.) 	<p>RUN: Off ERR.: Flicker</p> <p>CPU Status: Stop</p>	QnA
	<p>[PARAMETER ERROR] The number of devices set at the PLC parameter device settings exceeds the possible CPU module range. ■Collateral information <ul style="list-style-type: none"> • Common Information:File name/Drive name • Individual Information:Parameter number ■Diagnostic Timing <ul style="list-style-type: none"> • At power-On/At reset/STOP → RUN/ At writing to programmable controller </p>			

Error Code	Error Contents and Cause	Corrective Action	LED Status CPU Status	Corresponding CPU
3004	<p>[PARAMETER ERROR] The parameter file is incorrect. Alternatively, the contents of the file are not parameters.</p> <p>■Collateral information <ul style="list-style-type: none"> • Common Information:File name/Drive name • Individual Information:Parameter number </p> <p>■Diagnostic Timing <ul style="list-style-type: none"> • At power-On/At reset/STOP → RUN/ At writing to programmable controller </p>	<p>Check whether the parameter file version is * * * .QPA, and check the file contents to be sure they are parameters.</p>	<p>RUN: Off ERR.: Flicker</p>	QnA
3100	<p>[LINK PARA. ERROR] Although the QnACPU is a control station or master station, the network parameters have not been written.</p> <p>■Collateral information <ul style="list-style-type: none"> • Common Information:File name/Drive name • Individual Information:Parameter number </p> <p>■Diagnostic Timing <ul style="list-style-type: none"> • At power ON/At reset/STOP → RUN </p>	<ul style="list-style-type: none"> • Correct and write the network parameters. • If the error occurs after correction, it suggests a hardware fault. (Contact your local Mitsubishi representative.) 	<p>CPU Status: Stop</p>	

Error Code	Error Contents and Cause	Corrective Action	LED Status CPU Status	Corresponding CPU
3101	<p>[LINK PARA. ERROR]</p> <ul style="list-style-type: none"> The network No. specified by a network parameter is different from that of the actually mounted network. The head I/O No. specified by a network parameter is different from that of the actually mounted I/O unit. The network class specified by a network parameter is different from that of the actually mounted network. The network refresh parameter of the MELSECNET/H, MELSECNET/10 is out of the specified area. <p>■Collateral informationmmon</p> <ul style="list-style-type: none"> Common Information:File name/Drive name Individual Information:Parameter number <p>■Diagnostic Timing</p> <ul style="list-style-type: none"> At power ON/At reset/STOP → RUN 	<ul style="list-style-type: none"> Check the network parameters and mounting status, and if they differ, match the network parameters and mounting status. <p>If any network parameter has been corrected, write it to the CPU module.</p> <ul style="list-style-type: none"> Confirm the setting of the number of extension stages of the extension base units. Check the connection status of the extension base units and extension cables. <p>When the GOT is bus-connected to the main base unit and extension base units, also check their connection status.</p> <p>If the error occurs after the above checks, the cause is a hardware fault. (Contact your local Mitsubishi representative, explaining a detailed description of the problem.)</p>	<p>RUN: Off ERR.: Flicker</p> <p>CPU Status: Stop</p>	QnA
3102	<p>[LINK PARA. ERROR]</p> <ul style="list-style-type: none"> The network module detected a network parameter error. <p>■Collateral informationmmon</p> <ul style="list-style-type: none"> Common Information:File name/Drive name Individual Information:Parameter number <p>■Diagnostic Timing</p> <ul style="list-style-type: none"> At power ON/At reset/STOP → RUN³ 	<ul style="list-style-type: none"> Correct and write the network parameters. If the error occurs after correction, it suggests a hardware fault. (Contact your local Mitsubishi representative.) 		

Error Code	Error Contents and Cause	Corrective Action	LED Status CPU Status	Corresponding CPU
3103	<p>[LINK PARA. ERROR]</p> <ul style="list-style-type: none"> • Although the number of modules has been set to one or greater number in the Ethernet network parameter setting, the number of actually mounted module is zero. • The start I/O No. of the Ethernet network parameter differs from the I/O No. of the actually mounted module. <p>■Collateral information</p> <ul style="list-style-type: none"> • Common Information:File name/Drive name • Individual Information:Parameter number <p>■Diagnostic Timing</p> <ul style="list-style-type: none"> • At power ON/At reset/STOP → RUN <hr/> <p>[LINK PARA. ERROR]</p> <ul style="list-style-type: none"> • AJ71QE71 does not exist in the position of I/O number set by the parameter. • I/O number designation is overlapping. • Numbers of the network parameter and loaded AJ71QE71 are different. • Ethernet (parameter + dedicated instruction) is set to more than five. <p>■Collateral information</p> <ul style="list-style-type: none"> • Common Information:File name/Drive name • Individual Information:Parameter number <p>■Diagnostic Timing</p> <ul style="list-style-type: none"> • At power ON/At reset/STOP → RUN 	<ul style="list-style-type: none"> • Correct and write the network parameters. • If the error occurs after correction, it suggests a hardware fault. (Contact your local Mitsubishi representative.) 	<p>RUN: Off ERR.: Flicker</p> <p>CPU Status: Stop</p>	QnA

Error Code	Error Contents and Cause	Corrective Action	LED Status CPU Status	Corre- sponding CPU
3104	<p>[LINK PARA. ERROR]</p> <ul style="list-style-type: none"> • The Ethernet and MELSECNET/10 use the same network number. • The network number, station number or group number set in the network parameter is out of range. • The specified I/O number is outside the range of the used CPU module. • The Ethernet-specific parameter setting is not normal. <p>■Collateral informationmmon</p> <ul style="list-style-type: none"> • Common Information:File name / Drive name • Individual Information:Parameter number <p>■Diagnostic Timing</p> <ul style="list-style-type: none"> • At power ON/At reset/STOP → RUN 	<ul style="list-style-type: none"> • Correct and write the network parameters. • If the error occurs after correction, it suggests a hardware fault. (Contact your local Mitsubishi representative.) 	<p>RUN: Off ERR.: Flicker</p> <p>CPU Status: Stop</p>	QnA
3105	<p>[LINK PARA. ERROR]</p> <p>The contents of the Ethernet parameter are incorrect.</p> <p>■Collateral informationmmon</p> <ul style="list-style-type: none"> • Common Information:File name / Drive name • Individual Information:Parameter number <p>■Diagnostic Timing</p> <ul style="list-style-type: none"> • At power ON/At reset/STOP → RUN 	Write after correcting parameters.		

Error Code	Error Contents and Cause	Corrective Action	LED Status CPU Status	Corre- sponding CPU
3107	<p>[LINK PARA. ERROR]</p> <ul style="list-style-type: none"> The CC-Link parameter setting is incorrect. The set mode is not allowed for the version of the mounted CC-Link module. <p>■Collateral informationmmon</p> <ul style="list-style-type: none"> Common Information:File name Individual Information:Parameter number <p>■Diagnostic Timing</p> <ul style="list-style-type: none"> At power ON/At reset/STOP → RUN 	Check the parameter setting.		
3200	<p>[SFC PARA. ERROR]</p> <p>The parameter setting is illegal.</p> <ul style="list-style-type: none"> Though Block 0 was set to "Automatic start" in the SFC setting of the PLC parameter dialog box, Block 0 does not exist. <p>■Collateral informationmmon</p> <ul style="list-style-type: none"> Common Information:File name Individual Information:Parameter number <p>■Diagnostic Timing</p> <ul style="list-style-type: none"> STOP → RUN 	Read the common information of the error using the peripheral device, check error step corresponding to its numerical value (program error location), and correct the problem.	RUN: Off ERR.: Flicker	QnA
3201	<p>[SFC PARA. ERROR]</p> <p>The block parameter setting is illegal.</p> <p>■Collateral informationmmon</p> <ul style="list-style-type: none"> Common Information:File name Individual Information:Parameter number <p>■Diagnostic Timing</p> <ul style="list-style-type: none"> STOP → RUN 		CPU Status: Stop	

Error Code	Error Contents and Cause	Corrective Action	LED Status CPU Status	Corresponding CPU
3202	<p>[SFC PARA. ERROR] The number of step relays specified in the device setting of the PLC parameter dialog box is less than that used in the program.</p> <p>■Collateral informationmmon</p> <ul style="list-style-type: none"> • Common Information:File name • Individual Information:Parameter number <p>■Diagnostic Timing</p> <ul style="list-style-type: none"> • STOP → RUN 	Read the common information of the error using the peripheral device, check error step corresponding to its numerical value (program error location), and correct the problem.	RUN: Off ERR.: Flicker CPU Status: Stop	QnA
3203	<p>[SFC PARA. ERROR] The execution type of the SFC program specified in the program setting of the PLC parameter dialog box is other than scan execution.</p> <p>■Collateral informationmmon</p> <ul style="list-style-type: none"> • Common Information:File name • Individual Information:Parameter number <p>■Diagnostic Timing</p> <ul style="list-style-type: none"> • At power ON/At reset/STOP → RUN 			

Error Code	Error Contents and Cause	Corrective Action	LED Status CPU Status	Corre- sponding CPU
4000	<p>[INSTRCT. CODE ERR]</p> <ul style="list-style-type: none"> The program contains an instruction code that cannot be decoded. An unusable instruction is included in the program. <p>■Collateral information</p> <ul style="list-style-type: none"> Common Information: Program error location Individual Information:— <p>■Diagnostic Timing</p> <ul style="list-style-type: none"> At power ON/At reset/STOP → RUN When instruction executed 			
4001	<p>[INSTRCT. CODE ERR]</p> <p>The program contains a dedicated instruction for SFC although it is not an SFC program.</p> <p>■Collateral information</p> <ul style="list-style-type: none"> Common Information: Program error location Individual Information:— <p>■Diagnostic Timing</p> <ul style="list-style-type: none"> At power ON/At reset/STOP → RUN When instruction executed 	Read the common information of the error using a peripheral device, check error step corresponding to its numerical value (program error location), and correct the problem.	<p>RUN: Off ERR.: Flicker</p> <p>CPU Status: Stop</p>	QnA
4002	<p>[INSTRCT. CODE ERR]</p> <ul style="list-style-type: none"> The name of dedicated instruction specified by the program is incorrect. The dedicated instruction specified by the program cannot be executed by the specified module. <p>■Collateral information</p> <ul style="list-style-type: none"> Common Information: Program error location Individual Information:— <p>■Diagnostic Timing</p> <ul style="list-style-type: none"> At power ON/At reset/STOP → RUN When instruction executed 			

Error Code	Error Contents and Cause	Corrective Action	LED Status CPU Status	Corre- sponding CPU
4003	<p>[INSTRCT. CODE ERR] The number of devices for the dedicated instruction specified by the program is incorrect.</p> <p>■Collateral information <ul style="list-style-type: none"> • Common Information:Program error location • Individual Information:– </p> <p>■Diagnostic Timing <ul style="list-style-type: none"> • At power ON/At reset/STOP → RUN When instruction executed </p>	Read the common information of the error using a peripheral device, check error step corresponding to its numerical value (program error location), and correct the problem.	RUN: Off ERR.: Flicker CPU Status: Stop	QnA
4004	<p>[INSTRCT. CODE ERR] The device which cannot be used by the dedicated instruction specified by the program is specified.</p> <p>■Collateral information <ul style="list-style-type: none"> • Common Information:Program error location • Individual Information:– </p> <p>■Diagnostic Timing <ul style="list-style-type: none"> • At power ON/At reset/STOP → RUN When instruction executed </p>			
4010	<p>[MISSING END INS.] There is no END (FEND) instruction in the program.</p> <p>■Collateral information <ul style="list-style-type: none"> • Common Information:Program error location • Individual Information:– </p> <p>■Diagnostic Timing <ul style="list-style-type: none"> • At power ON/At reset/STOP → RUN </p>			

Error Code	Error Contents and Cause	Corrective Action	LED Status CPU Status	Corre- sponding CPU			
4020	<p>[CAN'T SET(P)] The total number of internal file pointers used by the program exceeds the number of internal file pointers set in the parameters.</p> <p>■Collateral informationmmon</p> <ul style="list-style-type: none"> • Common Information:Program error location • Individual Information:– <p>■Diagnostic Timing</p> <ul style="list-style-type: none"> • At power ON/At reset/STOP → RUN 			QnA			
4021	<p>[CAN'T SET(P)]</p> <ul style="list-style-type: none"> • The common pointer Nos. assigned to files overlap. • The local pointer Nos. assigned to files overlap. <p>■Collateral informationmmon</p> <ul style="list-style-type: none"> • Common Information:Program error location • Individual Information:– <p>■Diagnostic Timing</p> <ul style="list-style-type: none"> • At power ON/At reset/STOP → RUN 				Read the common information of the error using a peripheral device, check error step corresponding to its numerical value (program error location), and correct the problem.	RUN: Off ERR.: Flicker	CPU Status: Stop
4030	<p>[CAN'T SET(I)] The allocation pointer Nos. assigned by files overlap.</p> <p>■Collateral informationmmon</p> <ul style="list-style-type: none"> • Common Information:Program error location • Individual Information:– <p>■Diagnostic Timing</p> <ul style="list-style-type: none"> • At power ON/At reset/STOP → RUN 						

Error Code	Error Contents and Cause	Corrective Action	LED Status CPU Status	Corresponding CPU
4100	<p>[OPERATION ERROR] The instruction cannot process the contained data.</p> <p>■Collateral informationmmon</p> <ul style="list-style-type: none"> • Common Information:Program error location • Individual Information:– <p>■Diagnostic Timing</p> <ul style="list-style-type: none"> • When instruction executed 			
4101	<p>[OPERATION ERROR]</p> <ul style="list-style-type: none"> • The number of setting data dealt with the instruction exceeds the applicable range. • The storage data and constant of the device specified by the instruction exceeds the applicable range. • When writing to the host CPU shared memory, the write prohibited area is specified for the write destination address. • The range of storage data of the device specified by the instruction is duplicated. • The device specified by the instruction exceeds the range of the number of device points. • The interrupt pointer No. specified by the instruction exceeds the applicable range. <p>■Collateral informationmmon</p> <ul style="list-style-type: none"> • Common Information:Program error location • Individual Information:– <p>■Diagnostic Timing</p> <ul style="list-style-type: none"> • When instruction executed 	Read the common information of the error using the peripheral device, check error step corresponding to its numerical value (program error location), and correct the problem.	RUN: Off/On ERR.: Flicker/ On CPU Status: Stop/ Continue *1	QnA

*1 CPU operation can be set in the parameters at error occurrence. (LED indication varies.)

Error Code	Error Contents and Cause	Corrective Action	LED Status CPU Status	Corresponding CPU
4102	<p>[OPERATION ERROR]</p> <ul style="list-style-type: none"> The network No. or station No. specified for the dedicated instruction is wrong. The link direct device (J□\□) setting is incorrect. The module No./ network No./ number of character strings exceeds the range that can be specified. <p>■Collateral information</p> <ul style="list-style-type: none"> Common Information: Program error location Individual Information:— <p>■Diagnostic Timing</p> <ul style="list-style-type: none"> When instruction executed 	Read the common information of the error using the peripheral device, check error step corresponding to its numerical value (program error location), and correct the problem.	RUN: Off/On ERR.: Flicker/ On CPU Status: Stop/ Continue*1	QnA
4103	<p>[OPERATION ERROR]</p> <p>The configuration of the PID dedicated instruction is incorrect.</p> <p>■Collateral information</p> <ul style="list-style-type: none"> Common Information: Program error location Individual Information:— <p>■Diagnostic Timing</p> <ul style="list-style-type: none"> When instruction executed 			
4104	<p>[OPERATION ERROR]</p> <p>The number of settings is beyond the range.</p> <p>■Collateral information</p> <ul style="list-style-type: none"> Common Information: Program error location Individual Information:— <p>■Diagnostic Timing</p> <ul style="list-style-type: none"> When instruction executed 	Read the common information of the error using peripheral device, and check and correct the program corresponding to that value (program error location).		Q4AR

*1 CPU operation can be set in the parameters at error occurrence. (LED indication varies.)

Error Code	Error Contents and Cause	Corrective Action	LED Status CPU Status	Corre- sponding CPU
4107	<p>[OPERATION ERROR] Numbers of execution to the CC-Link instruction are beyond 32.</p> <p>■Collateral information <ul style="list-style-type: none"> • Common Information: Program error location • Individual Information:— </p> <p>■Diagnostic Timing <ul style="list-style-type: none"> • When instruction executed </p>	Set the numbers of execution to the CC-Link instruction to 32 or less.	RUN: Off/On ERR.: Flicker/ On	QnA
4108	<p>[OPERATION ERROR] The CC-Link parameter is not set when the CC-Link instruction is executed.</p> <p>■Collateral information <ul style="list-style-type: none"> • Common Information: Program error location • Individual Information:— </p> <p>■Diagnostic Timing <ul style="list-style-type: none"> • When instruction executed </p>	Execute the CC-Link instruction after setting the CC-Link parameter.	CPU Status: Stop/ Continue *1	
4200	<p>[FOR NEXT ERROR] No NEXT instruction was executed following the execution of a FOR instruction. Alternatively, there are fewer NEXT instructions than FOR instructions.</p> <p>■Collateral information <ul style="list-style-type: none"> • Common Information: Program error location • Individual Information:— </p> <p>■Diagnostic Timing <ul style="list-style-type: none"> • When instruction executed </p>	Read the common information of the error using the peripheral device, check error step corresponding to its numerical value (program error location), and correct the problem.	RUN: Off ERR.: Flicker CPU Status: Stop	

*1 CPU operation can be set in the parameters at error occurrence. (LED indication varies.)

Error Code	Error Contents and Cause	Corrective Action	LED Status CPU Status	Corresponding CPU
4201	<p>[FOR NEXT ERROR] A NEXT instruction was executed although no FOR instruction has been executed. Alternatively, there are more NEXT instructions than FOR instructions.</p> <p>■Collateral informationmmon</p> <ul style="list-style-type: none"> • Common Information:Program error location • Individual Information:– <p>■Diagnostic Timing</p> <ul style="list-style-type: none"> • When instruction executed 	Read the common information of the error using the peripheral device, check error step corresponding to its numerical value (program error location), and correct the problem.	RUN: Off ERR.: Flicker CPU Status: Stop	QnA
4202	<p>[FOR NEXT ERROR] More than 16 nesting levels are programmed.</p> <p>■Collateral informationmmon</p> <ul style="list-style-type: none"> • Common Information:Program error location • Individual Information:– <p>■Diagnostic Timing</p> <ul style="list-style-type: none"> • When instruction executed 	Keep nesting levels at 16 or under.		
4203	<p>[FOR NEXT ERROR] A BREAK instruction was executed although no FOR instruction has been executed prior to that.</p> <p>■Collateral informationmmon</p> <ul style="list-style-type: none"> • Common Information:Program error location • Individual Information:– <p>■Diagnostic Timing</p> <ul style="list-style-type: none"> • When instruction executed 	Read the common information of the error using the peripheral device, check error step corresponding to its numerical value (program error location), and correct the problem.		
4210	<p>[CAN'T EXECUTE(P)] The CALL instruction is executed, but there is no subroutine at the specified pointer.</p> <p>■Collateral informationmmon</p> <ul style="list-style-type: none"> • Common Information:Program error location • Individual Information:– <p>■Diagnostic Timing</p> <ul style="list-style-type: none"> • When instruction executed 	Read the common information of the error using the peripheral device, check error step corresponding to its numerical value (program error location), and correct the problem.		

Error Code	Error Contents and Cause	Corrective Action	LED Status CPU Status	Corresponding CPU
4211	<p>[CAN'T EXECUTE(P)] There was no RET instruction in the executed subroutine program.</p> <p>■Collateral informationmmon</p> <ul style="list-style-type: none"> • Common Information:Program error location • Individual Information:– <p>■Diagnostic Timing</p> <ul style="list-style-type: none"> • When instruction executed 	Read the common information of the error using the peripheral device, check error step corresponding to its numerical value (program error location), and correct the problem.	RUN: Off ERR.: Flicker	QnA
4212	<p>[CAN'T EXECUTE(P)] The RET instruction exists before the FEND instruction of the main routine program.</p> <p>■Collateral informationmmon</p> <ul style="list-style-type: none"> • Common Information:Program error location • Individual Information:– <p>■Diagnostic Timing</p> <ul style="list-style-type: none"> • When instruction executed 			
4213	<p>[CAN'T EXECUTE(P)] More than 16 nesting levels are programmed.</p> <p>■Collateral informationmmon</p> <ul style="list-style-type: none"> • Common Information:Program error location • Individual Information:– <p>■Diagnostic Timing</p> <ul style="list-style-type: none"> • When instruction executed 	Keep nesting levels at 16 or under.	CPU Status: Stop	
4220	<p>[CAN'T EXECUTE(I)] Though an interrupt input occurred, the corresponding interrupt pointer does not exist.</p> <p>■Collateral informationmmon</p> <ul style="list-style-type: none"> • Common Information:Program error location • Individual Information:– <p>■Diagnostic Timing</p> <ul style="list-style-type: none"> • When instruction executed 	Read the common information of the error using the peripheral device, check error step corresponding to its numerical value (program error location), and correct the problem.		

Error Code	Error Contents and Cause	Corrective Action	LED Status CPU Status	Corresponding CPU
4221	<p>[CAN'T EXECUTE(I)] An IRET instruction does not exist in the executed interrupt program.</p> <p>■Collateral informationmmon</p> <ul style="list-style-type: none"> • Common Information:Program error location • Individual Information:– <p>■Diagnostic Timing</p> <ul style="list-style-type: none"> • When instruction executed 	Read the common information of the error using the peripheral device, check error step corresponding to its numerical value (program error location), and correct the problem.	RUN: Off ERR.: Flicker CPU Status: Stop	QnA
4223	<p>[CAN'T EXECUTE(I)] The IRET instruction exists before the FEND instruction of the main routine program.</p> <p>■Collateral informationmmon</p> <ul style="list-style-type: none"> • Common Information:Program error location • Individual Information:– <p>■Diagnostic Timing</p> <ul style="list-style-type: none"> • When instruction executed 			
4230	<p>[INST. FORMAT ERR.] The number of CHK and CHKEND instructions is not equal.</p> <p>■Collateral informationmmon</p> <ul style="list-style-type: none"> • Common Information:Program error location • Individual Information:– <p>■Diagnostic Timing</p> <ul style="list-style-type: none"> • When instruction executed 			
4231	<p>[INST. FORMAT ERR.] The number of IX and IXEND instructions is not equal.</p> <p>■Collateral informationmmon</p> <ul style="list-style-type: none"> • Common Information:Program error location • Individual Information:– <p>■Diagnostic Timing</p> <ul style="list-style-type: none"> • When instruction executed 			

Error Code	Error Contents and Cause	Corrective Action	LED Status CPU Status	Corresponding CPU
4235	<p>[INST. FORMAT ERR.] The configuration of the check conditions for the CHK instruction is incorrect. Alternatively, a CHK instruction has been used in a low speed execution type program.</p> <p>■Collateral informationmmon</p> <ul style="list-style-type: none"> • Common Information:Program error location • Individual Information:– <p>■Diagnostic Timing</p> <ul style="list-style-type: none"> • When instruction executed 	Read the common information of the error using the peripheral device, check error step corresponding to its numerical value (program error location), and correct the problem.	<p>RUN: Off ERR.: Flicker</p> <p>CPU Status: Stop</p>	QnA
4300	<p>[EXTEND INST. ERR.] The designation of a MELSECNET/MINI-S3 master module control instruction was wrong.</p> <p>■Collateral informationmmon</p> <ul style="list-style-type: none"> • Common Information:Program error location • Individual Information:– <p>■Diagnostic Timing</p> <ul style="list-style-type: none"> • When instruction executed 	Read the common information of the error using the peripheral device, check error step corresponding to its numerical value (program error location), and correct the problem.	<p>RUN: Off/On ERR.: Flicker/ On</p> <p>CPU Status: Stop/ Continue *1</p>	
4301	<p>[EXTEND INST. ERR.] The designation of an AD57/AD58 control instruction was wrong.</p> <p>■Collateral informationmmon</p> <ul style="list-style-type: none"> • Common Information:Program error location • Individual Information:– <p>■Diagnostic Timing</p> <ul style="list-style-type: none"> • When instruction executed 	Read the common information of the error using the peripheral device, check error step corresponding to its numerical value (program error location), and correct the problem.	<p>RUN: Off/On ERR.: Flicker/ On</p> <p>CPU Status: Stop/ Continue *1</p>	
4400	<p>[SFCP. CODE ERROR] No SFCP or SFCPEND instruction in SFC program.</p> <p>■Collateral informationmmon</p> <ul style="list-style-type: none"> • Common Information:Program error location • Individual Information:– <p>■Diagnostic Timing</p> <p>STOP → RUN</p>	Write the program to the CPU module again using GX Developer.	<p>RUN: Off/On ERR.: Flicker/ On</p> <p>CPU Status: Stop/ Continue *1</p>	

*1 CPU operation can be set in the parameters at error occurrence. (LED indication varies.)

Error Code	Error Contents and Cause	Corrective Action	LED Status CPU Status	Corresponding CPU
4410	<p>[CAN'T SET(BL)] The block number designated by the SFC program exceeds the range.</p> <p>■Collateral informationmmon</p> <ul style="list-style-type: none"> • Common Information:Program error location • Individual Information:– <p>■Diagnostic Timing</p> <ul style="list-style-type: none"> • STOP → RUN 	Write the program to the CPU module again using GX Developer.	RUN: Off/On ERR.: Flicker/ On CPU Status: Stop/ Continue *1	QnA
4411	<p>[CAN'T SET(BL)] Block number designations overlap in SFC program.</p> <p>■Collateral informationmmon</p> <ul style="list-style-type: none"> • Common Information:Program error location • Individual Information:– <p>■Diagnostic Timing</p> <ul style="list-style-type: none"> • STOP → RUN 			
4420	<p>[CAN'T SET(S)] A step number designated in an SFC program exceeds the range.</p> <p>■Collateral informationmmon</p> <ul style="list-style-type: none"> • Common Information:Program error location • Individual Information:– <p>■Diagnostic Timing</p> <ul style="list-style-type: none"> • STOP → RUN 			
4421	<p>[CAN'T SET(S)] Total number of steps in all SFC programs exceed the maximum.</p> <p>■Collateral informationmmon</p> <ul style="list-style-type: none"> • Common Information:Program error location • Individual Information:– <p>■Diagnostic Timing</p> <ul style="list-style-type: none"> • STOP → RUN 			

*1 CPU operation can be set in the parameters at error occurrence. (LED indication varies.)

Error Code	Error Contents and Cause	Corrective Action	LED Status CPU Status	Corresponding CPU
4422	<p>[CAN'T SET(S)] Step number designations overlap in SFC program.</p> <p>■Collateral informationmmon</p> <ul style="list-style-type: none"> • Common Information:Program error location • Individual Information:– <p>■Diagnostic Timing</p> <ul style="list-style-type: none"> • STOP → RUN 	Write the program to the CPU module again using GX Developer.	RUN: Off/On ERR.: Flicker/ On CPU Status: Stop/ Continue *1	QnA
4500	<p>[SFCP. FORMAT ERR.] The numbers of BLOCK and BEND instructions in an SFC program are not equal.</p> <p>■Collateral informationmmon</p> <ul style="list-style-type: none"> • Common Information:Program error location • Individual Information:– <p>■Diagnostic Timing</p> <ul style="list-style-type: none"> • STOP → RUN 			
4501	<p>[SFCP. FORMAT ERR.] The configuration of the STEP* to TRAN* to TSET to SEND instructions in the SFC program is incorrect.</p> <p>■Collateral informationmmon</p> <ul style="list-style-type: none"> • Common Information:Program error location • Individual Information:– <p>■Diagnostic Timing</p> <ul style="list-style-type: none"> • STOP → RUN 	Write the program to the CPU module again using the peripheral device.	RUN: Off ERR.: Flicker CPU Status: Stop	
4502	<p>[SFCP. FORMAT ERR.] The structure of the SFC program is illegal.</p> <ul style="list-style-type: none"> • STEPI* instruction does not exist in the block of the SFC program. <p>■Collateral informationmmon</p> <ul style="list-style-type: none"> • Common Information:Program error location • Individual Information:– <p>■Diagnostic Timing</p> <ul style="list-style-type: none"> • STOP → RUN 			

*1 CPU operation can be set in the parameters at error occurrence. (LED indication varies.)

Error Code	Error Contents and Cause	Corrective Action	LED Status CPU Status	Corre- sponding CPU
4503	<p>[SFCP. FORMAT ERR.] The structure of the SFC program is illegal.</p> <ul style="list-style-type: none"> The step specified in the TSET instruction does not exist. In jump transition, the host step number was specified as the destination step number. <p>■Collateral informationmmon</p> <ul style="list-style-type: none"> Common Information:Program error location Individual Information:– <p>■Diagnostic Timing</p> <ul style="list-style-type: none"> STOP → RUN 	<ul style="list-style-type: none"> Write the program to the CPU module again using GX Developer. Read the common information of the error using GX Developer, and check and correct the error step corresponding to that value (program error location). 	RUN: Off ERR.: Flicker	QnA
4504	<p>[SFCP. FORMAT ERR.] The structure of the SFC program is illegal.</p> <ul style="list-style-type: none"> The step specified in the TAND instruction does not exist. <p>■Collateral informationmmon</p> <ul style="list-style-type: none"> Common Information:Program error location Individual Information:– <p>■Diagnostic Timing</p> <ul style="list-style-type: none"> STOP → RUN 	Write the program to the CPU module again using GX Developer.	CPU Status: Stop	
4600	<p>[SFCP. OPE. ERROR] The SFC program contains data that cannot be processed.</p> <p>■Collateral informationmmon</p> <ul style="list-style-type: none"> Common Information:Program error location Individual Information:– <p>■Diagnostic Timing</p> <ul style="list-style-type: none"> When instruction executed 	Read common information of the error using the peripheral device, check error step corresponding to its numerical value (program error location), and correct the problem.	RUN: Off/On ERR.: Flicker/ On CPU Status: Stop/ Continue *1	

*1 CPU operation can be set in the parameters at error occurrence. (LED indication varies.)

Error Code	Error Contents and Cause	Corrective Action	LED Status CPU Status	Corresponding CPU
4601	<p>[SFCP. OPE. ERROR] Exceeds device range that can be designated by the SFC program.</p> <p>■Collateral informationmmon</p> <ul style="list-style-type: none"> • Common Information:Program error location • Individual Information:– <p>■Diagnostic Timing</p> <ul style="list-style-type: none"> • When instruction executed 	Read common information of the error using the peripheral device, check error step corresponding to its numerical value (program error location), and correct the problem.	RUN: Off/On ERR.: Flicker/ On	QnA
4602	<p>[SFCP. OPE. ERROR] The START instruction in an SFC program is preceded by an END instruction.</p> <p>■Collateral informationmmon</p> <ul style="list-style-type: none"> • Common Information:Program error location • Individual Information:– <p>■Diagnostic Timing</p> <ul style="list-style-type: none"> • When instruction executed 		CPU Status: Stop/ Continue *1	
4610	<p>[SFCP. EXE. ERROR] The active step information at presumptive start of the SFC program is incorrect.</p> <p>■Collateral informationmmon</p> <ul style="list-style-type: none"> • Common Information:Program error location • Individual Information:– <p>■Diagnostic Timing</p> <ul style="list-style-type: none"> • STOP → RUN 	Read common information of the error using the peripheral device, check error step corresponding to its numerical value (program error location), and correct the problem. The program is automatically subjected to an initial start.	RUN: On ERR.: On	
4611	<p>[SFCP. EXE. ERROR] Key-switch was reset during RUN when presumptive start was designated for SFC program.</p> <p>■Collateral informationmmon</p> <ul style="list-style-type: none"> • Common Information:Program error location • Individual Information:– <p>■Diagnostic Timing</p> <ul style="list-style-type: none"> • STOP → RUN 		CPU Status: Continue	

*1 CPU operation can be set in the parameters at error occurrence. (LED indication varies.)

Error Code	Error Contents and Cause	Corrective Action	LED Status CPU Status	Corresponding CPU
4620	<p>[BLOCK EXE. ERROR] Startup was executed at a block in the SFC program that was already started up.</p> <p>■Collateral informationmmon</p> <ul style="list-style-type: none"> • Common Information:Program error location • Individual Information:– <p>■Diagnostic Timing</p> <ul style="list-style-type: none"> • When instruction executed 	<p>Read common information of the error using the peripheral device, check error step corresponding to its numerical value (program error location), and correct the problem.</p>	<p>RUN: Off ERR.: Flicker</p> <p>CPU Status: Stop</p>	QnA
4621	<p>[BLOCK EXE. ERROR] Startup was attempted at a block that does not exist in the SFC program.</p> <p>■Collateral informationmmon</p> <ul style="list-style-type: none"> • Common Information:Program error location • Individual Information:– <p>■Diagnostic Timing</p> <ul style="list-style-type: none"> • When instruction executed 	<ul style="list-style-type: none"> • Read the common information of the error using GX Developer, and check and correct the error step corresponding to that value (program error location). • Turn ON if the special relay SM321 is OFF. 		
4630	<p>[STEP EXE. ERROR] Startup was executed at a block in the SFC program that was already started up.</p> <p>■Collateral informationmmon</p> <ul style="list-style-type: none"> • Common Information:Program error location • Individual Information:– <p>■Diagnostic Timing</p> <ul style="list-style-type: none"> • When instruction executed 	<p>Read common information of the error using the peripheral device, check error step corresponding to its numerical value (program error location), and correct the problem.</p>		

Error Code	Error Contents and Cause	Corrective Action	LED Status CPU Status	Corre- sponding CPU
4631	<p>[STEP EXE. ERROR]</p> <ul style="list-style-type: none"> Startup was attempted at the step that does not exist in the SFC program. Or, the step that does not exist in the SFC program was specified for end. Forced transition was executed based on the transition condition that does not exist in the SFC program. Or, the transition condition for forced transition that does not exist in the SFC program was canceled. <p>■Collateral informationmmon</p> <ul style="list-style-type: none"> Common Information:Program error location Individual Information:– <p>■Diagnostic Timing</p> <ul style="list-style-type: none"> When instruction executed 	<ul style="list-style-type: none"> Read the common information of the error using the peripheral device, and check and correct the error step corresponding to that value (program error location). Turn ON if the special relay SM321 is OFF. 	RUN: Off ERR.: Flicker	QnA
4632	<p>[STEP EXE. ERROR]</p> <p>There were too many simultaneous active steps in blocks that can be designated by the SFC program.</p> <p>■Collateral informationmmon</p> <ul style="list-style-type: none"> Common Information:Program error location Individual Information:– <p>■Diagnostic Timing</p> <ul style="list-style-type: none"> When instruction executed 	Read common information of the error using the peripheral device, check error step corresponding to its numerical value (program error location), and correct the problem.	CPU Status: Stop	
4633	<p>[STEP EXE. ERROR]</p> <p>There were too many simultaneous active steps in all blocks that can be designated.</p> <p>■Collateral informationmmon</p> <ul style="list-style-type: none"> Common Information:Program error location Individual Information:– <p>■Diagnostic Timing</p> <ul style="list-style-type: none"> When instruction executed 			

Error Code	Error Contents and Cause	Corrective Action	LED Status CPU Status	Corre- sponding CPU
5000	<p>[WDT ERROR]</p> <ul style="list-style-type: none"> The scan time of the initial execution type program exceeded the initial execution monitoring time specified in the PLC RAS setting of the PLC parameter. <p>■Collateral informationmmon</p> <ul style="list-style-type: none"> Common Information:Time (value set) Individual Information:Time (value actually measured) <p>■Diagnostic Timing</p> <ul style="list-style-type: none"> Always 	<ul style="list-style-type: none"> Read the individual information of the error from the peripheral device, check its value (time), and shorten the scan time. Change the initial execution monitoring time or the WDT value in the PLC RAS setting of the PLC parameter. Resolve the endless loop caused by jump transition. 	RUN: Off ERR.: Flicker	QnA
5001	<p>[WDT ERROR]</p> <ul style="list-style-type: none"> The scan time of the program exceeded the WDT value specified in the PLC RAS setting of the PLC parameter. <p>■Collateral informationmmon</p> <ul style="list-style-type: none"> Common Information:Time (value set) Individual Information:Time (value actually measured) <p>■Diagnostic Timing</p> <ul style="list-style-type: none"> Always 	<ul style="list-style-type: none"> Read the individual information of the error from the peripheral device, check its value (time), and shorten the scan time. Change the initial execution monitoring time or the WDT value in the PLC RAS setting of the PLC parameter. Resolve the endless loop caused by jump transition. Check the number of interrupt program executions with the peripheral device and reducethe number of interrupts. 	CPU Status: Stop	

Error Code	Error Contents and Cause	Corrective Action	LED Status CPU Status	Corresponding CPU
5010	<p>[PRG. TIME OVER] The program scan time exceeded the constant scan setting time specified in the PLC RAS setting of the PLC parameter.</p> <p>■Collateral informationmmon</p> <ul style="list-style-type: none"> • Common Information:Time (value set) • Individual Information:Time (value actually measured) <p>■Diagnostic Timing</p> <ul style="list-style-type: none"> • Always 	<ul style="list-style-type: none"> • Review the constant scan setting time. • Review the constant scan setting time and low speed program execution time in the PLC parameter so that the excess time of constant scan can be fully secured. 	RUN: On ERR.: On CPU Status: Continue	QnA
	<p>[PRG. TIME OVER] The low speed program execution time specified in the PLC RAS setting of the PLC parameter exceeded the excess time of the constant scan.</p> <p>■Collateral informationmmon</p> <ul style="list-style-type: none"> • Common Information:Time (value set) • Individual Information:Time (value actually measured) <p>■Diagnostic Timing</p> <ul style="list-style-type: none"> • Always 			
5011	<p>[PRG. TIME OVER] The scan time of the low speed execution type program exceeded the low speed execution watch time specified in the PLC RAS setting of the PLC parameter dialog box.</p> <p>■Collateral informationmmon</p> <ul style="list-style-type: none"> • Common Information:Time (value set) • Individual Information:Time (value actually measured) <p>■Diagnostic Timing</p> <ul style="list-style-type: none"> • Always 	Read the individual information of the error using the peripheral device, check the numerical value (time) there, and shorten scan time if necessary. Change the low speed execution watch time in the PLC RAS setting of the PLC parameter dialog box.		

Error Code	Error Contents and Cause	Corrective Action	LED Status CPU Status	Corre- sponding CPU
6000	<p>[PRG. VERIFY ERR.] The control system and standby system in the redundant system do not have the same programs and parameters. (This can be detected from the standby system of the redundant system.)</p> <p>■Collateral informationmmon</p> <ul style="list-style-type: none"> • Common Information:File name • Individual Information:– <p>■Diagnostic Timing</p> <ul style="list-style-type: none"> • Always 	Synchronise the programs and parameters of the control system and standby system.	<p>RUN: Off ERR.: Flicker</p> <p>CPU Status: Stop</p>	Q4AR
6010	<p>[MODE. VERIFY ERR.] The operational status of the control system and standby system in the redundant system is not the same. (This can be detected from the standby system of the redundant system.)</p> <p>■Collateral informationmmon</p> <ul style="list-style-type: none"> • Common Information:– • Individual Information:– <p>■Diagnostic Timing</p> <ul style="list-style-type: none"> • Always 	Synchronise the operation statuses of the control system and standby system.	<p>RUN: On ERR.: On</p>	
6100	<p>[TRUCKINERR.] A CPU module tracking memory error was detected during initial. (This can be detected from the control system or standby system of the redundant system.)</p> <p>■Collateral informationmmon</p> <ul style="list-style-type: none"> • Common Information:– • Individual Information:– <p>■Diagnostic Timing</p> <ul style="list-style-type: none"> • At power ON/At reset/STOP → RUN 	Hardware fault of the CPU module. (Please contact your local nearest Mitsubishi or sales representative, explaining a detailed description of the problem. Change the CPU modules in order of the standby system CPU module and control system CPU module.)	CPU Status: Continue	

Error Code	Error Contents and Cause	Corrective Action	LED Status CPU Status	Corresponding CPU
6101	<p>[TRUCKIN ERR.] The CPU module detected an error during the handshake for tracking. (This can be detected from the control system or standby system of the redundant system.)</p> <p>■Collateral informationmmon</p> <ul style="list-style-type: none"> • Common Information:– • Individual Information:– <p>■Diagnostic Timing</p> <ul style="list-style-type: none"> • When an END instruction executed 	Check the condition of the other stations.	RUN: On ERR.: On CPU Status: Continue	Q4AR
6200	<p>[CONTROL EXE.] The standby system in a redundant system is switched to the control system. (This can be detected from the standby system of the redundant system.)</p> <p>■Collateral informationmmon</p> <ul style="list-style-type: none"> • Common Information:Reason(s) for system switching • Individual Information:– <p>■Diagnostic Timing</p> <ul style="list-style-type: none"> • Always 	Check the control system condition.	RUN: On ERR.: Off CPU Status: Continue	
6210	<p>[CONTROL WAIT] The control system in a redundant system is switched to the standby system. (This can be detected from the standby system of the redundant system.)</p> <p>■Collateral informationmmon</p> <ul style="list-style-type: none"> • Common Information:Reason(s) for system switching • Individual Information:– <p>■Diagnostic Timing</p> <ul style="list-style-type: none"> • Always 	Check the control system condition.	RUN: On ERR.: Off CPU Status: Continue	

Error Code	Error Contents and Cause	Corrective Action	LED Status CPU Status	Corre- sponding CPU
6220	<p>[CAN'T EXE. CHANGE]</p> <ul style="list-style-type: none"> • Since the standby system is in an error or similar status in the redundant system, the control system cannot be switched to the standby system. • When an attempt was made to execute system switching, the control system could not be switched to the standby system due to a network error of the control system. <p>(This can be detected from the control system of the redundant system.)</p> <p>■Collateral informationmmon</p> <ul style="list-style-type: none"> • Common Information:Reason(s) for system switching • Individual Information:– <p>■Diagnostic Timing</p> <ul style="list-style-type: none"> • At switching request 	Check the standby system condition.	RUN: On ERR.: On CPU Status: Continue	Q4AR
6221	<p>[CAN'T EXE. CHANGE]</p> <p>Switching is disabled because of a bus switching module error. (This can be detected from the control system of the redundant system.)</p> <p>■Collateral informationmmon</p> <ul style="list-style-type: none"> • Common Information:Reason(s) for system switching • Individual Information:– <p>■Diagnostic Timing</p> <ul style="list-style-type: none"> • At switching request 	This is a bus switching module hardware fault. (Contact your local Mitsubishi representative.)		
6230	<p>[DUAL SYS. ERROR]</p> <p>The link module mounted on the standby system CPU module is the remote master station.</p> <p>■Collateral informationmmon</p> <ul style="list-style-type: none"> • Common Information:– • Individual Information:– <p>■Diagnostic Timing</p> <ul style="list-style-type: none"> • Always 	Check the system configuration status.		

Error Code	Error Contents and Cause	Corrective Action	LED Status CPU Status	Corresponding CPU
9000	<p>[F****] Annunciator (F) was set ON</p> <p>■Collateral informationmmmon</p> <ul style="list-style-type: none"> • Common Information:Program error location • Individual Information:Annunciator number <p>■Diagnostic Timing</p> <ul style="list-style-type: none"> • When instruction executed 	Read the individual information of the error using the peripheral device, and check the program corresponding to the numerical value (annunciator number).	RUN: On ERR.: On/Off *2 CPU Status: Continue RUN: USER LED On ERR.: USER LED On CPU Status: Continue	QnA
9010	<p>[<CHK>ERR ***-***] Error detected by the CHK instruction.</p> <p>■Collateral informationmmmon</p> <ul style="list-style-type: none"> • Common Information:Program error location • Individual Information:Failure No. <p>■Diagnostic Timing</p> <ul style="list-style-type: none"> • When instruction executed 	Read the individual information of the error using the peripheral device, and check the program corresponding to the numerical value (error number) there.	RUN: On ERR.: Off CPU Status: Continue RUN: USER LED On ERR.: USER LED On CPU Status: Continue	

*2 For the Basic model QCPU, the special register (SD207 to DS209) for LED indication priority can turn off the indication. (The LED indication is always OFF for the High Performance model QCPU, Process CPU, Redundant CPU, and Universal model QCPU.)

6.4 Canceling of Errors

Q series CPU module can perform the cancel operation for errors only when the errors allow the CPU module to continue its operation.

To cancel the errors, follow the steps shown below.

- 1) Eliminate the cause of the error.
- 2) Store the error code to be canceled in the special register SD50.
- 3) Energize the special relay SM50 (OFF → ON).
- 4) The error to be canceled is canceled.

After the CPU module is reset by the canceling of the error, the special relays, special registers, and LEDs associated with the error are returned to the status under which the error occurred.

If the same error occurs again after the cancellation of the error, it will be registered again in the error history.

When multiple enunciators(F) detected are canceled, the first one with No. F only is canceled.

Refer to the following manual for details of error canceling.

→ QCPU User's Manual (Function Explanation, Program Fundamentals)

POINT
(1) When the error is canceled with the error code to be canceled stored in the SD50, the lower one digit of the code is neglected. (Example) If error codes 2100 and 2101 occur, and error code 2100 to cancel error code 2101. If error codes 2100 and 2111 occur, error code 2111 is not canceled even if error code 2100 is canceled.
(2) Errors developed due to trouble in other than the CPU module are not canceled even if the special relay (SM50) and special register (SD50) are used to cancel the error. (Example) Since "SP. UNIT DOWN" is the error that occurred in the base unit (including the extension cable), intelligent function module, etc. the error cause cannot be removed even if the error is canceled by the special relay (SM50) and special register (SD50). Refer to the error code list and remove the error cause.

7. TRANSPORTATION PRECAUTIONS

When transporting lithium batteries, make sure to treat them based on the transportation regulations.

7.1 Relevant Models

The batteries for the QnACPU are classified as shown in the table below.

Product Name	Model	Description	Handled As
QnA series battery	A6BAT	Lithium battery	Non-dangerous goods
QnA series battery memory card	Q1MEM-128S, Q1MEM-128SE, Q1MEM-1MS, Q1MEM-1MSE, Q1MEM-1MSF, Q1MEM-256S, Q1MEM-256SE, Q1MEM-256SF, Q1MEM-2MS, Q1MEM-2MSF, Q1MEM-512S, Q1MEM-512SE, Q1MEM-512F, Q1MEM-64S, Q1MEM-64SE	Packed with lithium coin battery (BR2325)	

7.2 Transportation Guidelines

Products are packed properly in compliance with the transportation regulations prior to shipment. When repacking any of the unpacked products to transport it to another location, make sure to observe the IATA Dangerous Goods Regulations, IMDG Code and other local transportation regulations.

For details, please consult your transportation company.

WARRANTY

Please confirm the following product warranty details before using this product.

1. Gratis Warranty Term and Gratis Warranty Range

If any faults or defects (hereinafter "Failure") found to be the responsibility of Mitsubishi occurs during use of the product within the gratis warranty term, the product shall be repaired at no cost via the sales representative or Mitsubishi Service Company.

However, if repairs are required onsite at domestic or overseas location, expenses to send an engineer will be solely at the customer's discretion. Mitsubishi shall not be held responsible for any re-commissioning, maintenance, or testing on-site that involves replacement of the failed module.

[Gratis Warranty Term]

The gratis warranty term of the product shall be for one year after the date of purchase or delivery to a designated place.

Note that after manufacture and shipment from Mitsubishi, the maximum distribution period shall be six (6) months, and the longest gratis warranty term after manufacturing shall be eighteen (18) months. The gratis warranty term of repair parts shall not exceed the gratis warranty term before repairs.

[Gratis Warranty Range]

- (1)The range shall be limited to normal use within the usage state, usage methods and usage environment, etc., which follow the conditions and precautions, etc., given in the instruction manual, user's manual and caution labels on the product.
- (2)Even within the gratis warranty term, repairs shall be charged for in the following cases.
 - 1.Failure occurring from inappropriate storage or handling, carelessness or negligence by the user. Failure caused by the user's hardware or software design.
 - 2.Failure caused by unapproved modifications, etc., to the product by the user.
 - 3.When the Mitsubishi product is assembled into a user's device, Failure that could have been avoided if functions or structures, judged as necessary in the legal safety measures the user's device is subject to or as necessary by industry standards, had been provided.
 - 4.Failure that could have been avoided if consumable parts (battery, backlight, fuse, etc.) designated in the instruction manual had been correctly serviced or replaced.
 - 5.Failure caused by external irresistible forces such as fires or abnormal voltages, and Failure caused by force majeure such as earthquakes, lightning, wind and water damage.
 - 6.Failure caused by reasons unpredictable by scientific technology standards at time of shipment from Mitsubishi.
 - 7.Any other failure found not to be the responsibility of Mitsubishi or that admitted not to be so by the user.

2. Onerous repair term after discontinuation of production

(1) Mitsubishi shall accept onerous product repairs for seven (7) years after production of the product is discontinued.

Discontinuation of production shall be notified with Mitsubishi Technical Bulletins, etc.

(2) Product supply (including repair parts) is not available after production is discontinued.

3. Overseas service

Overseas, repairs shall be accepted by Mitsubishi's local overseas FA Center. Note that the repair conditions at each FA Center may differ.

4. Exclusion of loss in opportunity and secondary loss from warranty liability

Regardless of the gratis warranty term, Mitsubishi shall not be liable for compensation of damages caused by any cause found not to be the responsibility of Mitsubishi, loss in opportunity, lost profits incurred to the user by Failures of Mitsubishi products, special damages and secondary damages whether foreseeable or not, compensation for accidents, and compensation for damages to products other than Mitsubishi products, replacement by the user, maintenance of on-site equipment, start-up test run and other tasks.

5. Changes in product specifications

The specifications given in the catalogs, manuals or technical documents are subject to change without prior notice.

Country/Region	Sales office/Tel	Country/Region	Sales office/Tel
U.S.A	Mitsubishi Electric Automation Inc. 500 Corporate Woods Parkway Vernon Hills, IL 60061, U.S.A. Tel : +1-847-478-2100	China	Mitsubishi Electric Automation (China) Ltd. 4/F Zhi Fu Plaza, No.80 Xin Chang Road, Shanghai 200003, China Tel : +86-21-6120-0808
Brazil	MELCO-TEC Rep. Com.e Assessoria Tecnica Ltda. Rua Correia Dias, 184, Edificio Paraiso Trade Center-8 andar Paraiso, Sao Paulo, SP Brazil Tel : +55-11-5908-8331	Taiwan	Setsuyo Enterprise Co., Ltd. 6F No.105 Wu-Kung 3rd.Rd, Wu-Ku Hsiang, Taipei Hsine, Taiwan Tel : +886-2-2299-2499
Germany	Mitsubishi Electric Europe B.V. German Branch Gothaer Strasse 8 D-40880 Ratingen, GERMANY Tel : +49-2102-486-0	Korea	Mitsubishi Electric Automation Korea Co., Ltd. 1480-6, Gayang-dong, Gangseo-ku Seoul 157-200, Korea Tel : +82-2-3660-9552
U.K	Mitsubishi Electric Europe B.V. UK Branch Travellers Lane, Hatfield, Hertfordshire., AL10 8XB, U.K. Tel : +44-1707-276100	Singapore	Mitsubishi Electric Asia Pte, Ltd. 307 Alexandra Road #05-01/02, Mitsubishi Electric Building, Singapore 159943 Tel : +65-6470-2480
Italy	Mitsubishi Electric Europe B.V. Italian Branch Centro Dir. Colleoni, Pal. Perseo-Ingr.2 Via Paracelso 12, I-20041 Agrate Brianza., Milano, Italy Tel : +39-039-60531	Thailand	Mitsubishi Electric Automation (Thailand) Co., Ltd. Bang-Chan Industrial Estate No.111 Moo 4, Serithai Rd, T.Kannayao, A.Kannayao, Bangkok 10230 Thailand Tel : +66-2-517-1326
Spain	Mitsubishi Electric Europe B.V. Spanish Branch Carretera de Rubi 76-80, E-08190 Sant Cugat del Valles, Barcelona, Spain Tel : +34-93-565-3131	Indonesia	P.T. Autoteknindo Sumber Makmur Muara Karang Selatan, Block A/Utara No.1 Kav. No.11 Kawasan Industri Pergudangan Jakarta - Utara 14440, P.O.Box 5045 Jakarta, 11050 Indonesia Tel : +62-21-6630833
France	Mitsubishi Electric Europe B.V. French Branch 25, Boulevard des Bouvets, F-92741 Nanterre Cedex, France Tel : +33-1-5568-5568	India	Messung Systems Pvt, Ltd. Electronic Sadan NO.III Unit No15, M.I.D.C Bhosari, Pune-411026, India Tel : +91-20-2712-3130
South Africa	Circuit Breaker Industries Ltd. Private Bag 2016, ZA-1600 Isando, South Africa Tel : +27-11-928-2000	Australia	Mitsubishi Electric Australia Pty. Ltd. 348 Victoria Road, Rydalmere, N.S.W 2116, Australia Tel : +61-2-9684-7777

MITSUBISHI ELECTRIC CORPORATION

HEAD OFFICE : TOKYO BUILDING, 2-7-3 MARUNOUCHI, CHYODA-KU, TOKYO 100-8310, JAPAN
NAGOYA WORKS : 1-14, YADA-MINAMI 5-CHOME, HIGASHI-KU, NAGOYA, JAPAN

When exported from Japan, this manual does not require application to the Ministry of Economy, Trade and Industry for service transaction permission.

Specifications subject to change without notice.